

Abinger Collection - 83904/05



Signature
DESIGN
ASHLEY

FEATURES

If you're looking to lighten the mood, you're sure to find this budget-conscious sectional beautifully fits the bill. Covered in a creme chenille upholstery loaded with plush texture, this less-is-more contemporary sectional is dressed to impress with angled side profiling and a track arm wrapped with a layer of pillowy softness for that little something extra. Open-ended chaise adds to this sectional's swank look.

SHOP THE COLLECTION

AVAILABLE COLORS

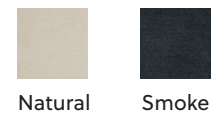

Ottoman
-08



LAF Corner
Chaise
-16



Sofa
-38



RAF Sofa
-67



Chair
-20



RAF Corner
Chaise
-17



Queen Sofa
Sleeper
-39



LAF Sofa
Sleeper
-69



Ottoman
-14



Loveseat
-35



LAF Sofa
-66



RAF Sofa
Sleeper
-70

Big or small... we fit your space.

ABINGER COLLECTION - 83904/05



Option 1

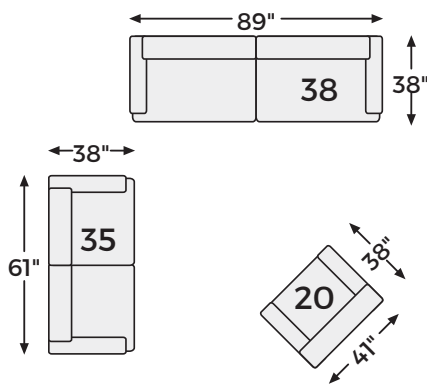

Option 2

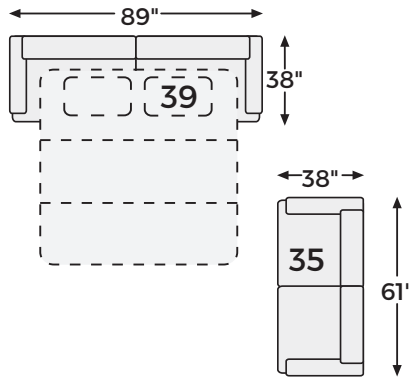

Option 3

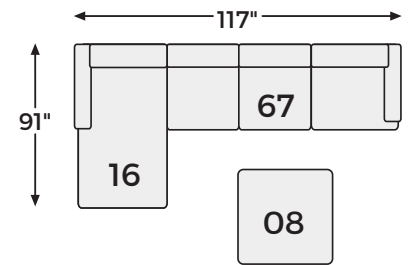

Option 4

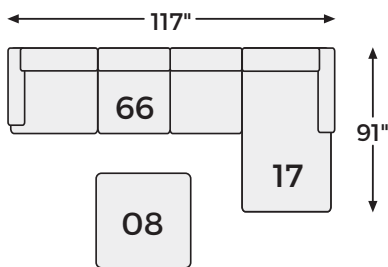

Option 5

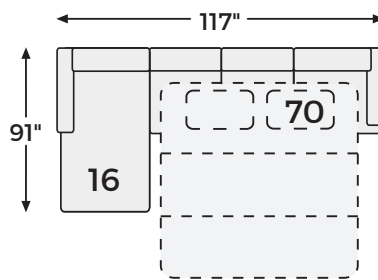

Option 6

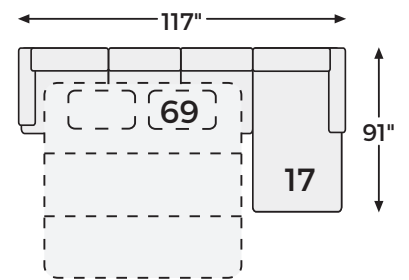

-08 OVERSIZED OTTOMAN



-20 CHAIR

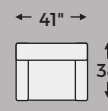

-35 LOVESEAT



-16 LAF CORNER CHAISE

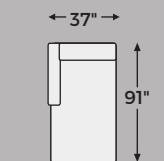

-17 RAF CORNER CHAISE

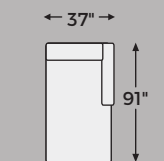

-39 QUEEN SOFA SLEEPER

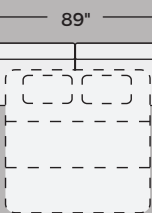

-69 LAF SOFA SLEEPER

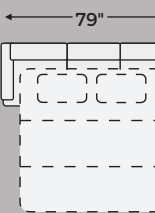

-70 RAF SOFA SLEEPER

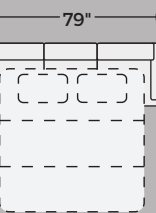

-38 SOFA

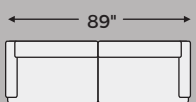

-14 OTTOMAN

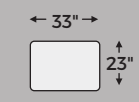

-66 LAF SOFA

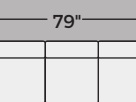

-67 RAF SOFA

