

accomplished 257

OUR FAVORITE CONFIGURATIONS

Reverse configurations available.

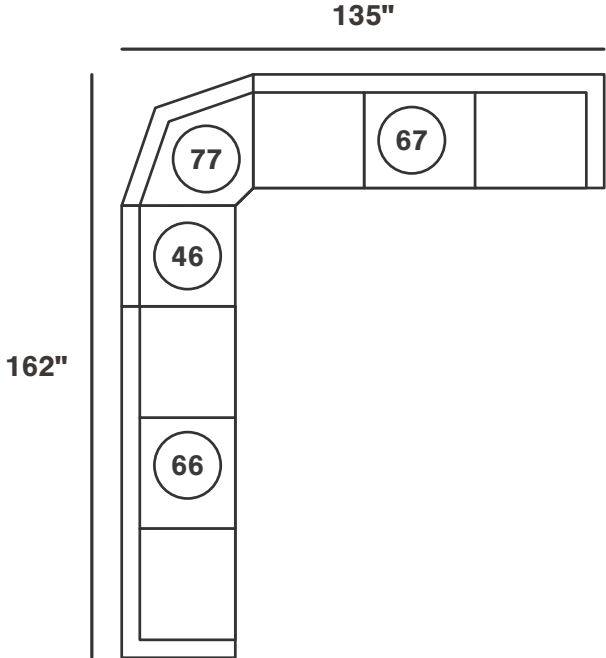
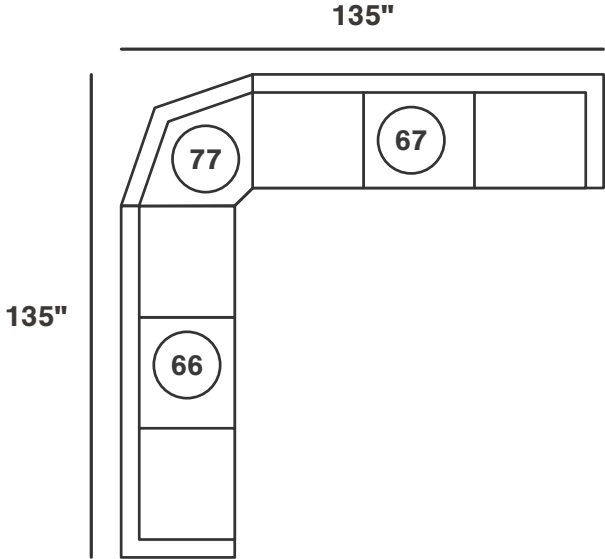

*All measurements are approximations.



accomplished 257

INDIVIDUAL PIECES

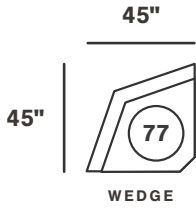
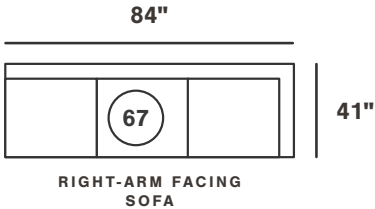
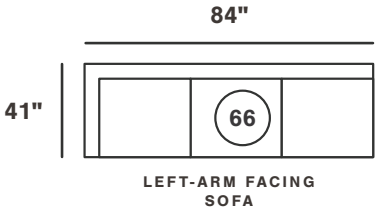
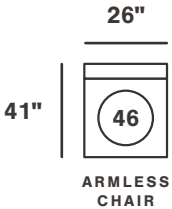

ADDITIONAL PIECES

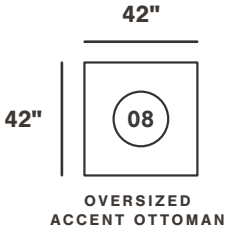

*All measurements are approximations.

avaliyah 581

OUR FAVORITE CONFIGURATIONS

Reverse configurations available.

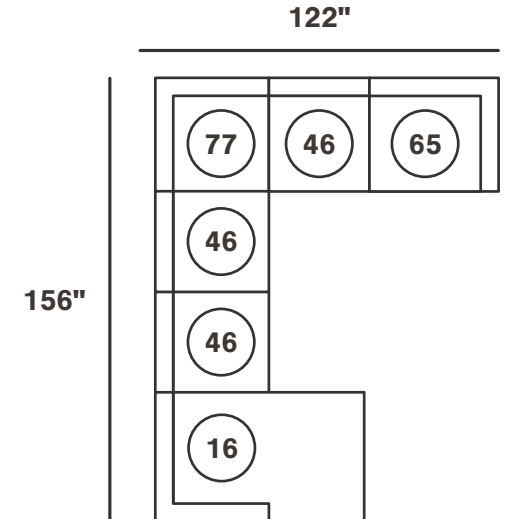
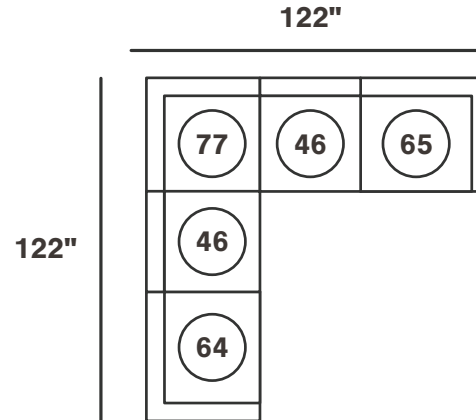
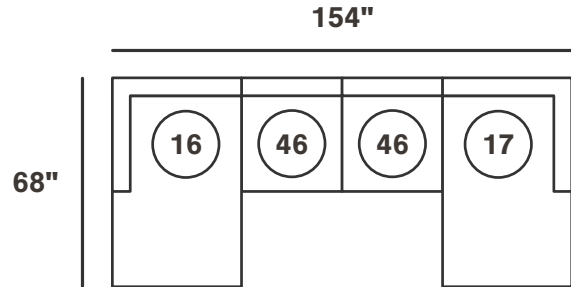
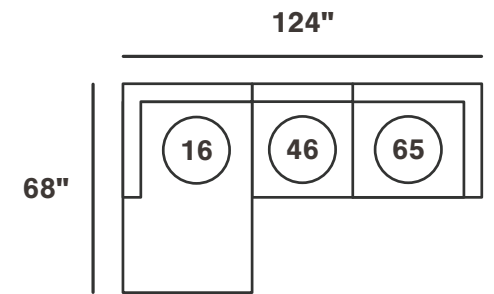
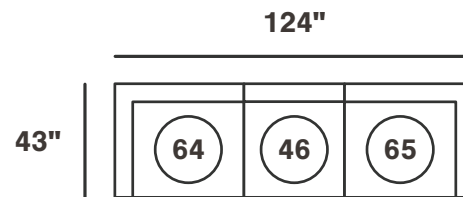
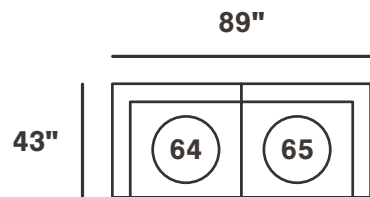

*All measurements are approximations.



avaliyah 581

INDIVIDUAL PIECES

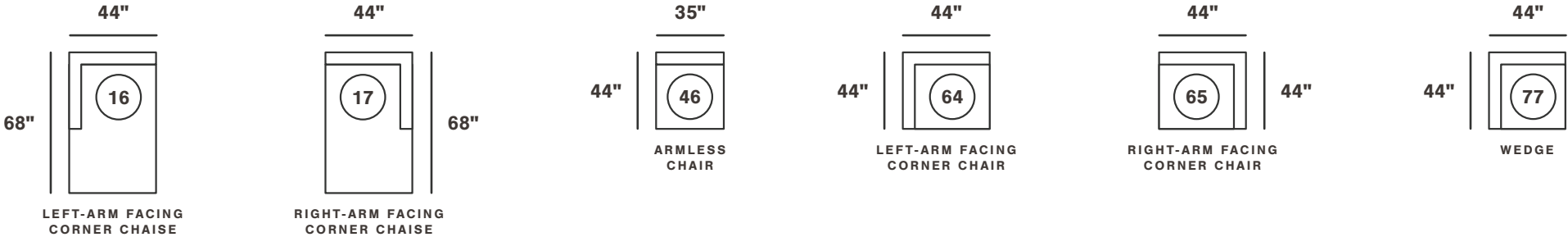

ADDITIONAL PIECES

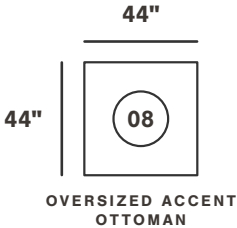

*All measurements are approximations.

claireah 906

OUR FAVORITE CONFIGURATIONS

Reverse configurations available.

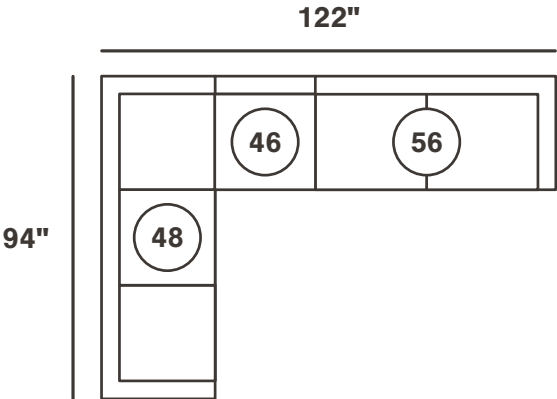
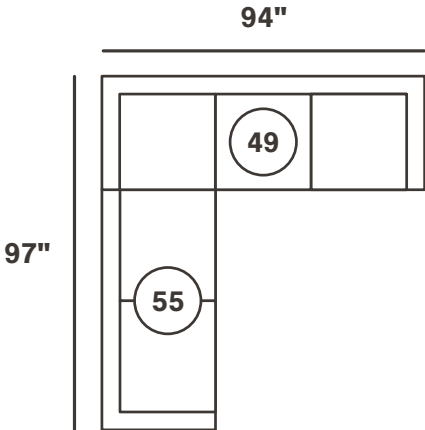

*All measurements are approximations.



claireah 906

INDIVIDUAL PIECES

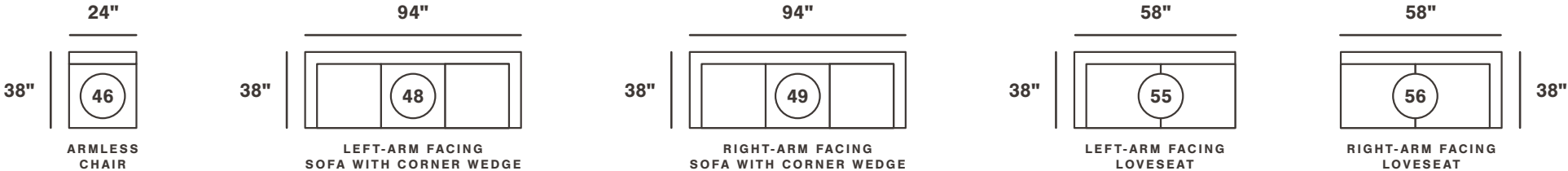

ADDITIONAL PIECES

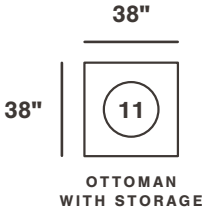

*All measurements are approximations.

huntsworth 397

OUR FAVORITE CONFIGURATIONS

Reverse configurations available.

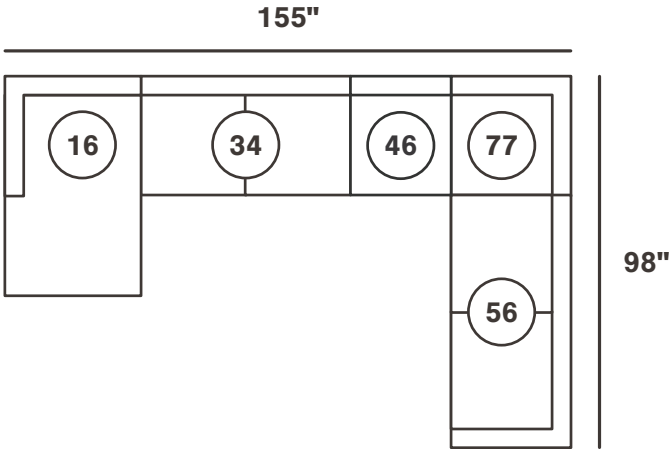
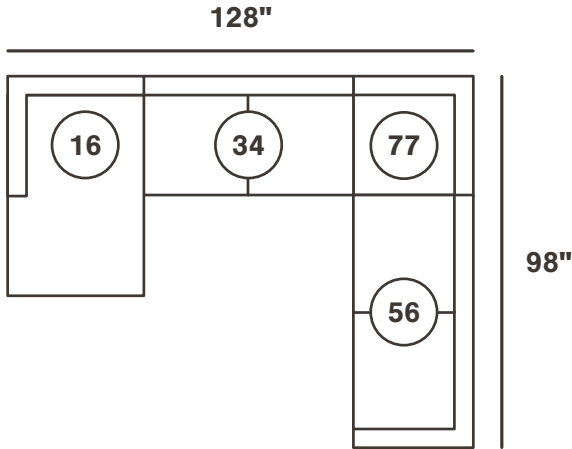
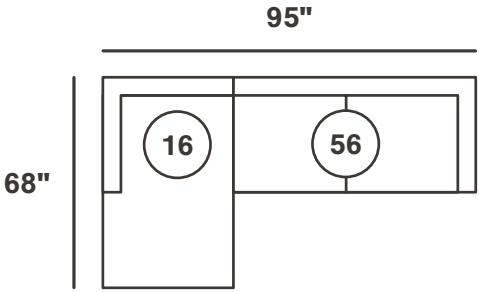

*All measurements are approximations.



huntsworth 397

INDIVIDUAL PIECES

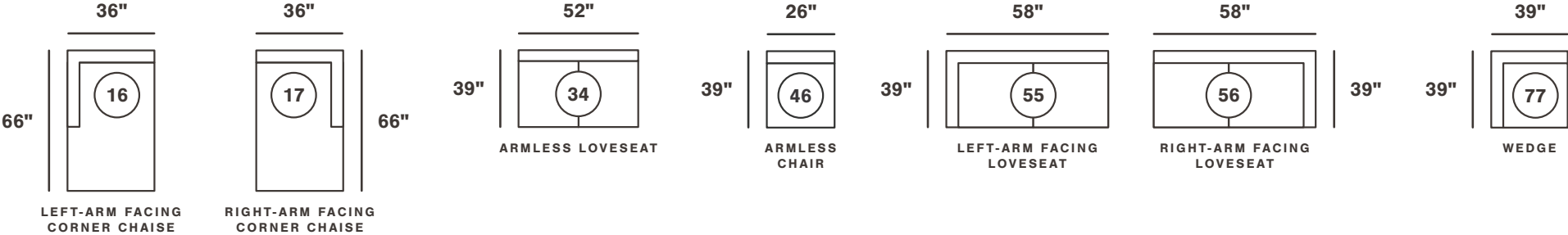

ADDITIONAL PIECES

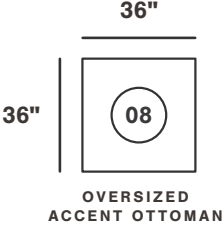

*All measurements are approximations.

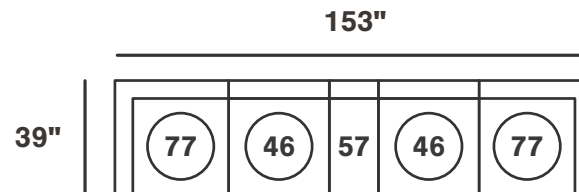
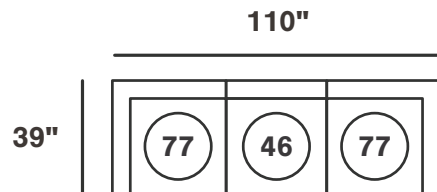
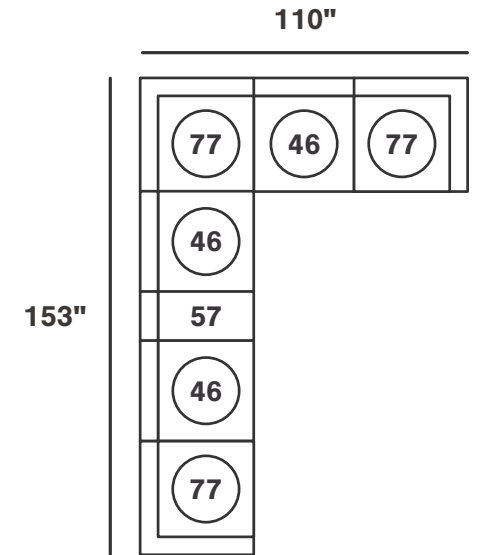
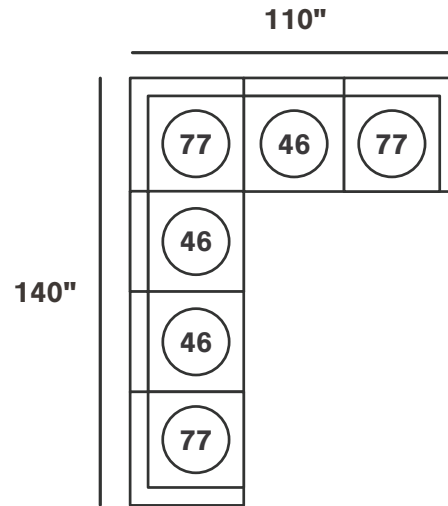
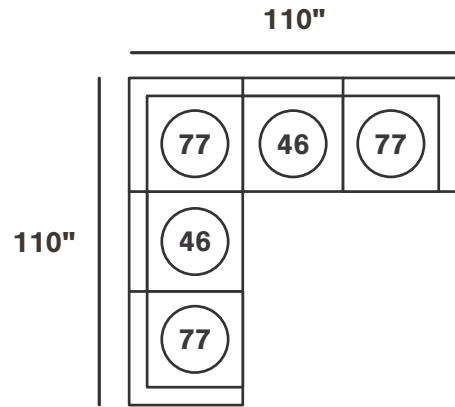

INDIVIDUAL PIECES

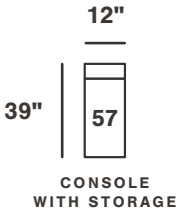
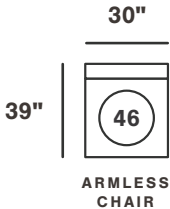
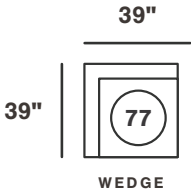

ADDITIONAL PIECES

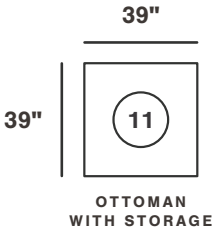

*All measurements are approximations.



laylabrook 922

OUR FAVORITE CONFIGURATIONS

Reverse configurations available.

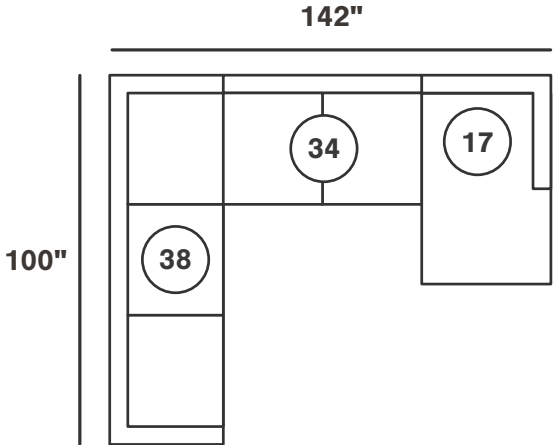
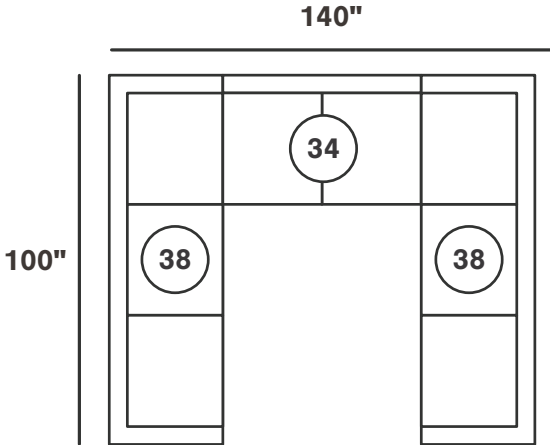
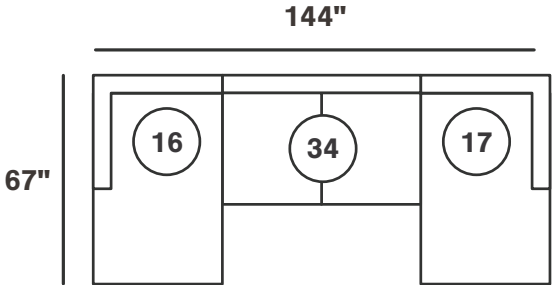

laylabrook 922

INDIVIDUAL PIECES

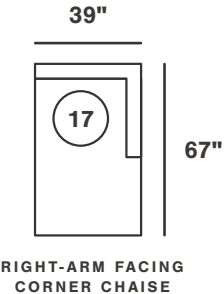
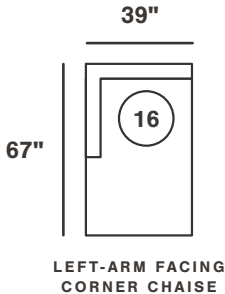
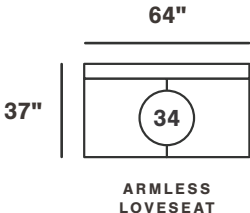
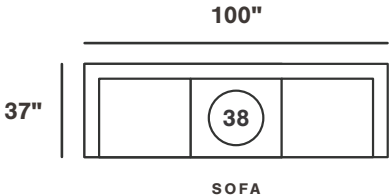

ADDITIONAL PIECES

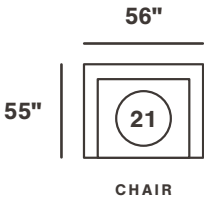
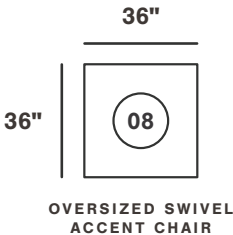

stupendous 259

OUR FAVORITE CONFIGURATIONS

Reverse configurations available.

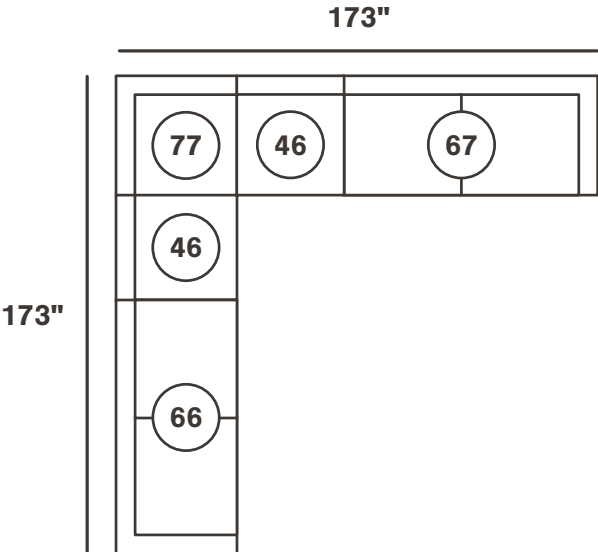
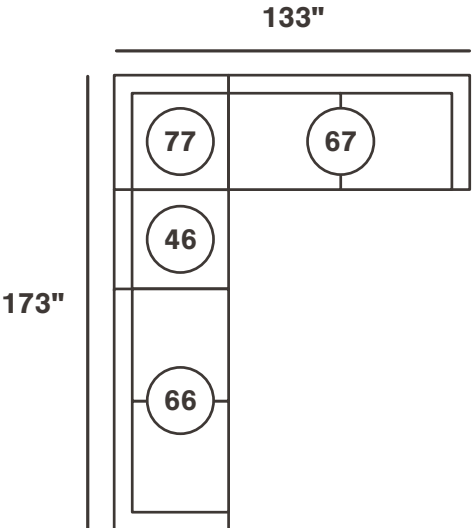
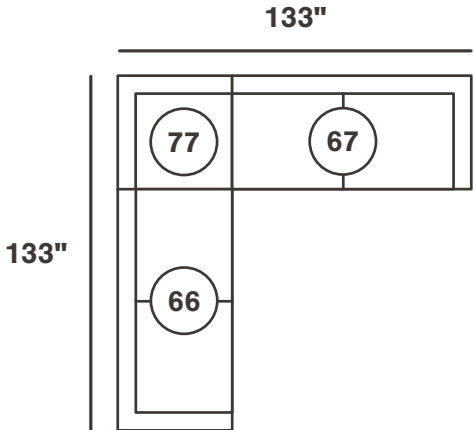

*All measurements are approximations.



stupendous 259

INDIVIDUAL PIECES

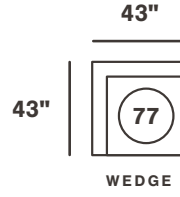
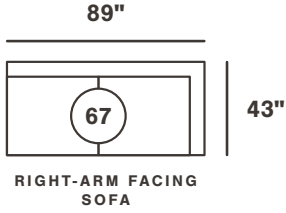
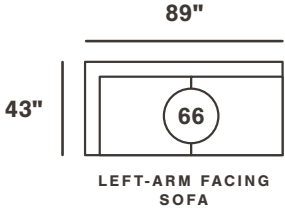

ADDITIONAL PIECES

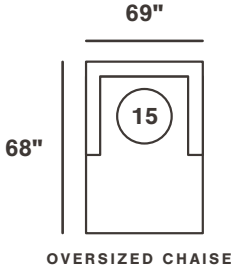
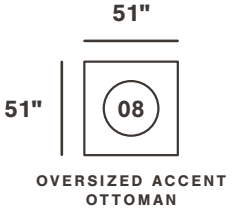

*All measurements are approximations.

abberson 253

OUR FAVORITE CONFIGURATIONS

Reverse configurations available.

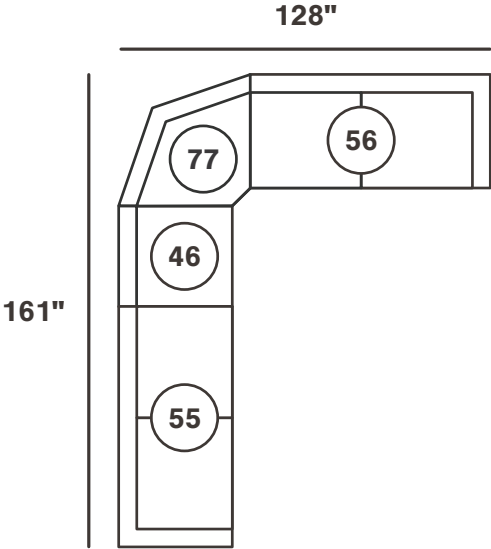
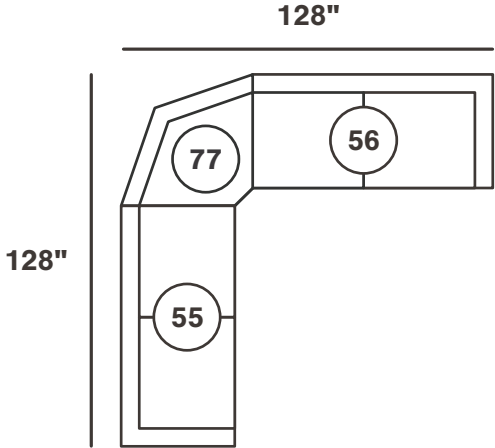

*All measurements are approximations.



abberson 253

INDIVIDUAL PIECES

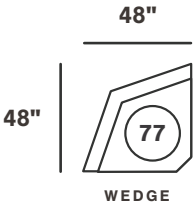
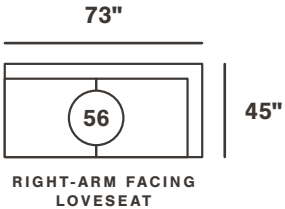
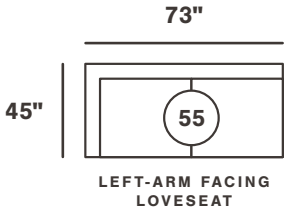
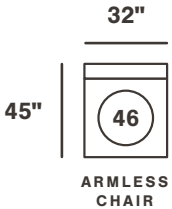

*All measurements are approximations.

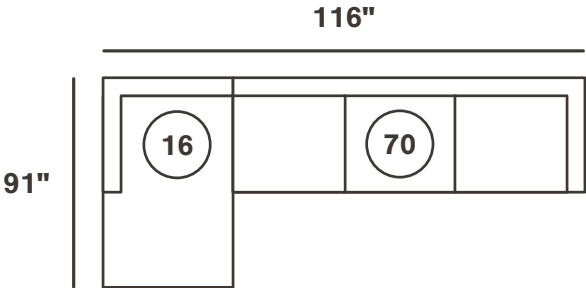
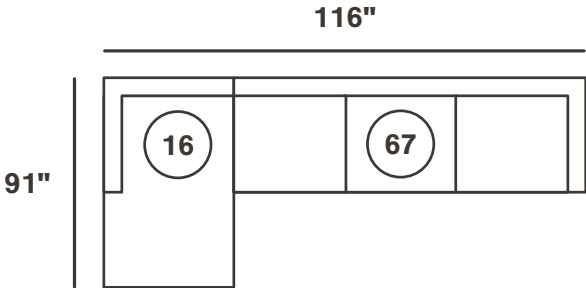

*All measurements are approximations.



INDIVIDUAL PIECES

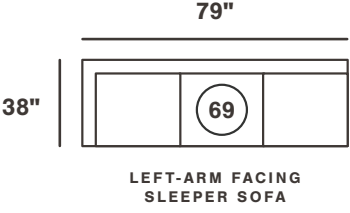
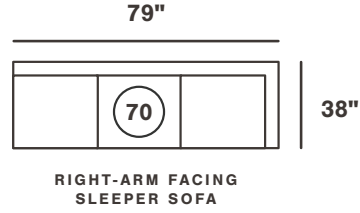
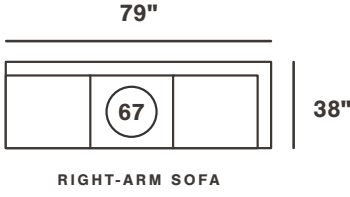
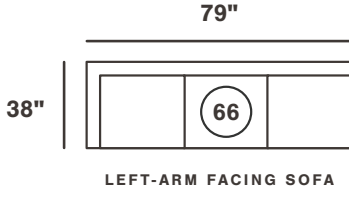
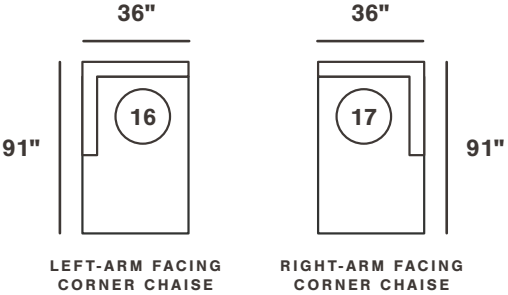

ADDITIONAL PIECES

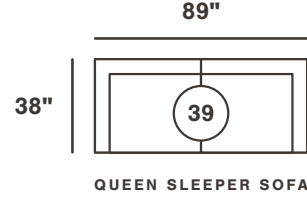
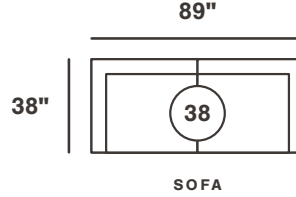
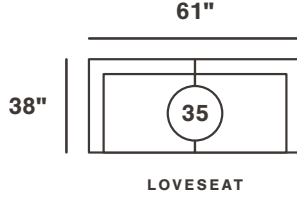
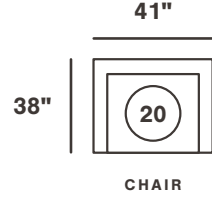
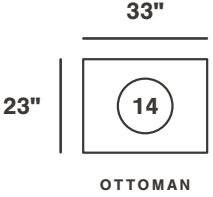
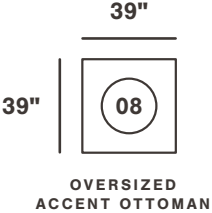

accrington 705

OUR FAVORITE CONFIGURATIONS

Reverse configurations available.

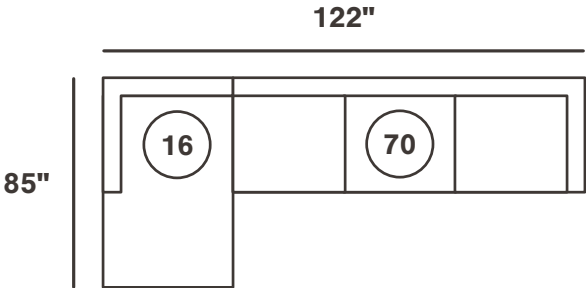
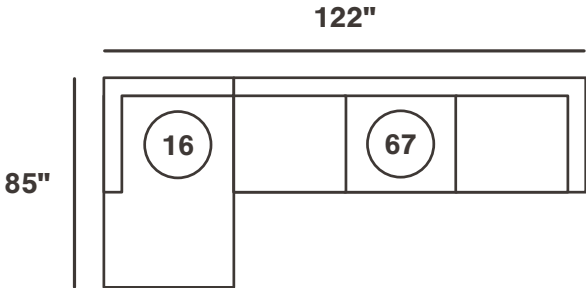

*All measurements are approximations.



accrington 705

INDIVIDUAL PIECES

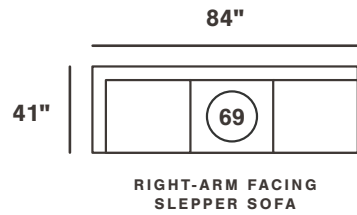
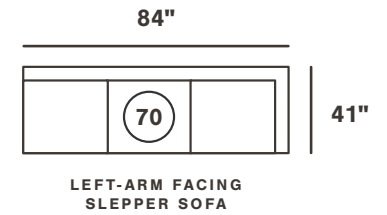
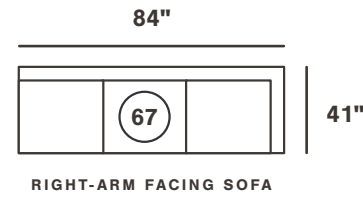
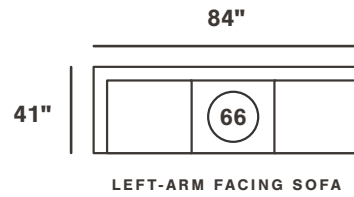
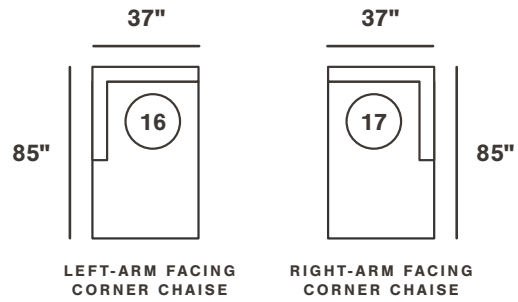

ADDITIONAL PIECES

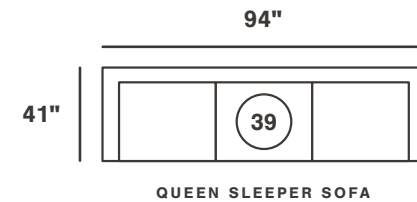
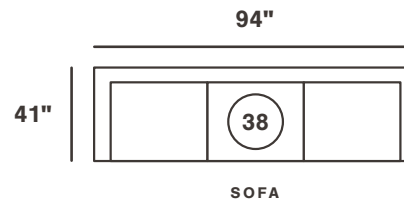
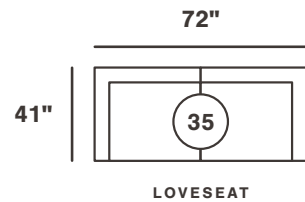
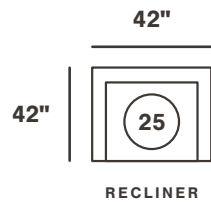
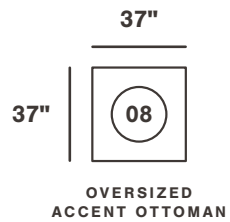

*All measurements are approximations.

alessio 824

OUR FAVORITE CONFIGURATIONS

Reverse configurations available.

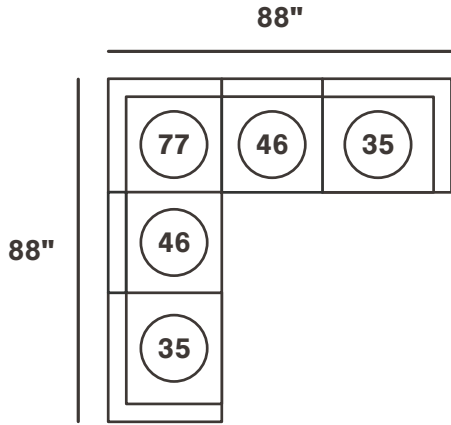
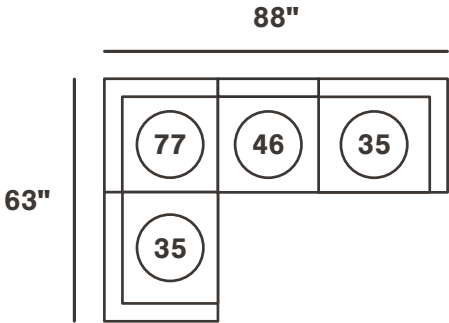

*All measurements are approximations.



alessio 824

INDIVIDUAL PIECES

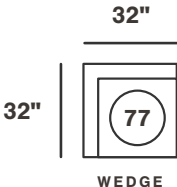
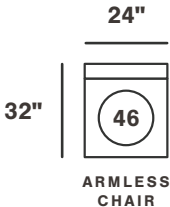
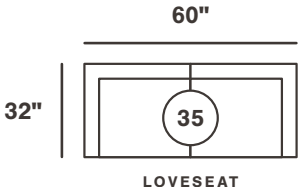

ADDITIONAL PIECES

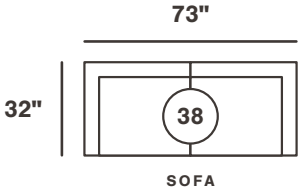

*All measurements are approximations.

altari 872

OUR FAVORITE CONFIGURATIONS

Reverse configurations available.

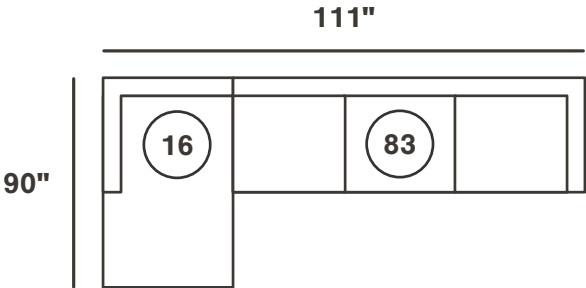
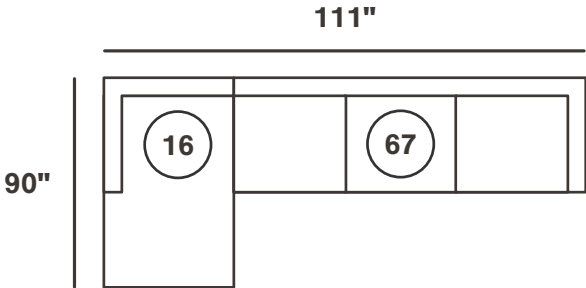

*All measurements are approximations.



INDIVIDUAL PIECES

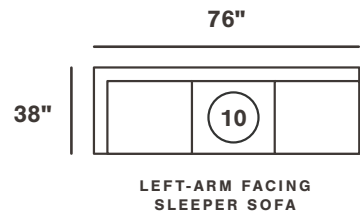
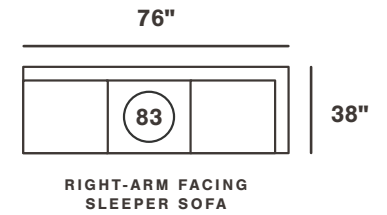
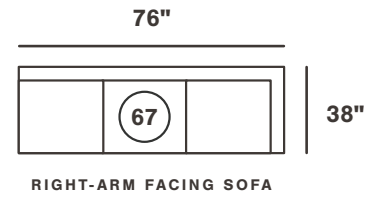
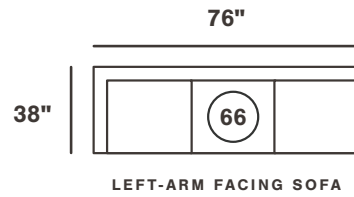
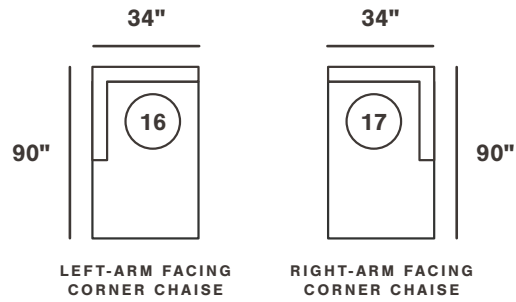

ADDITIONAL PIECES

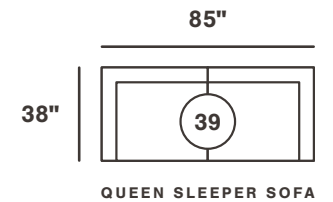
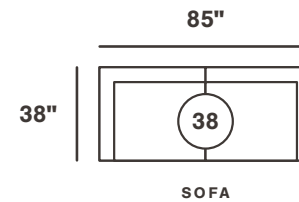
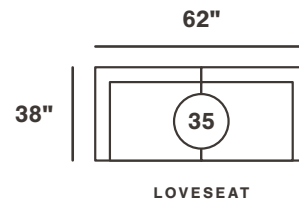
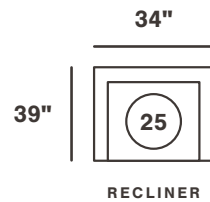
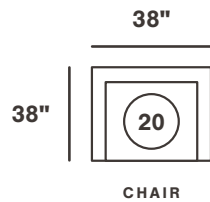
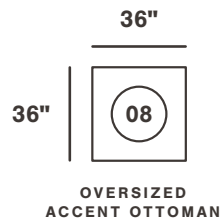

ambrielle 119

OUR FAVORITE CONFIGURATIONS

Reverse configurations available.

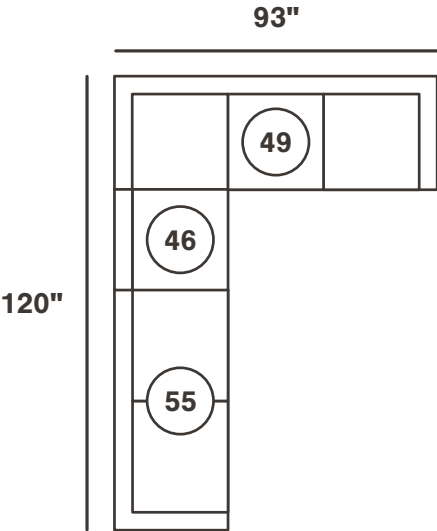
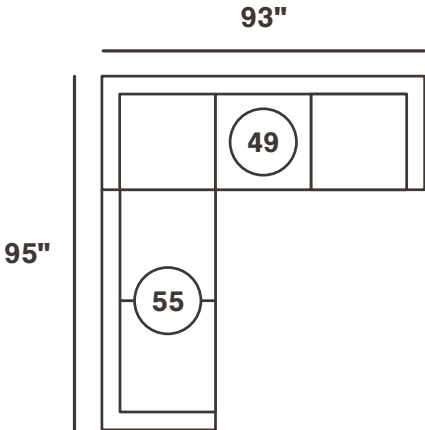

*All measurements are approximations.



ambrielle 119

INDIVIDUAL PIECES

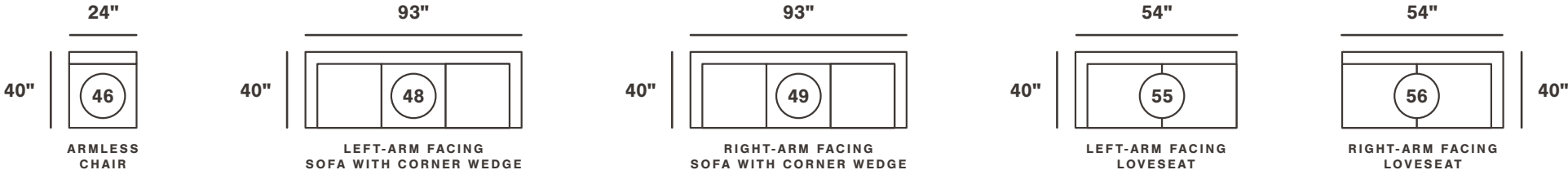

ADDITIONAL PIECES

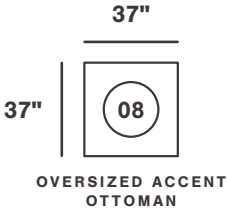

*All measurements are approximations.

baskove 111
OUR FAVORITE CONFIGURATIONS

Reverse configurations available.

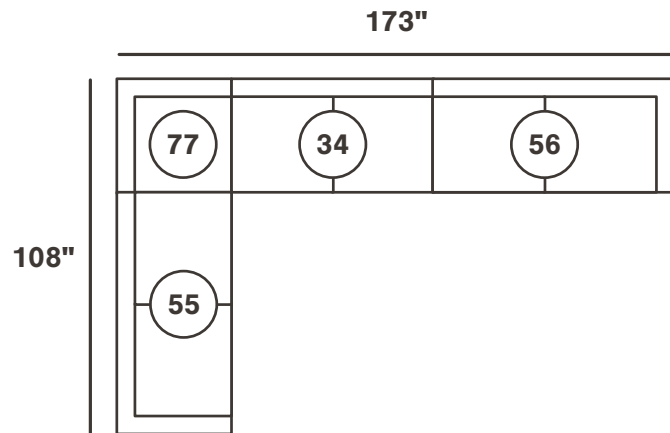
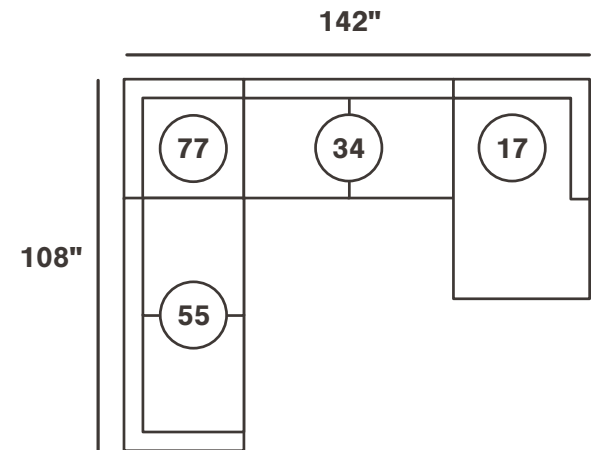
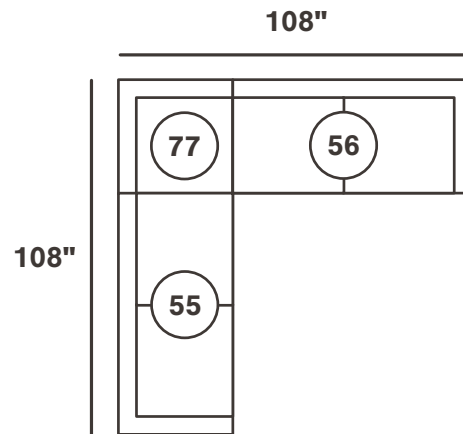
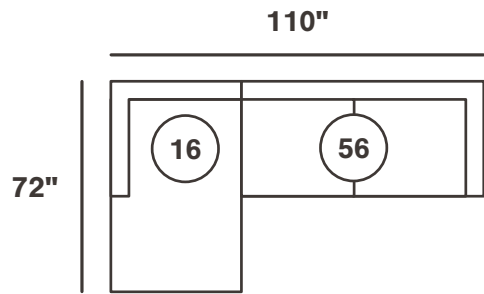

*All measurements are approximations.



baskove 111

INDIVIDUAL PIECES

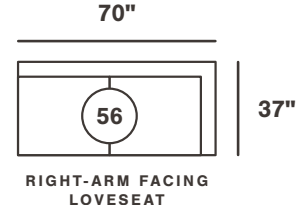
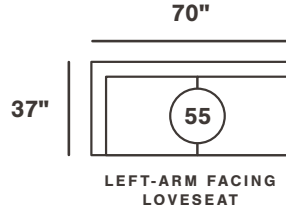
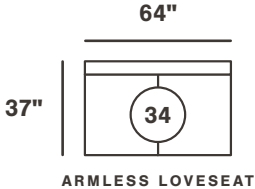
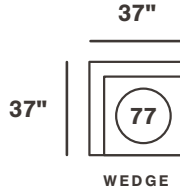
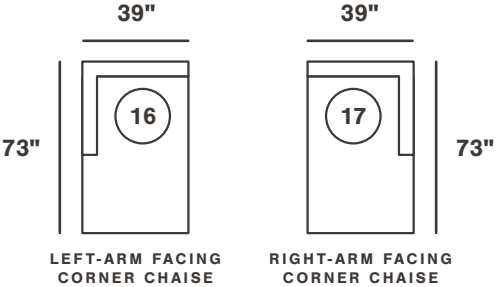

*All measurements are approximations.

bayless 523

OUR FAVORITE CONFIGURATIONS

Reverse configurations available.

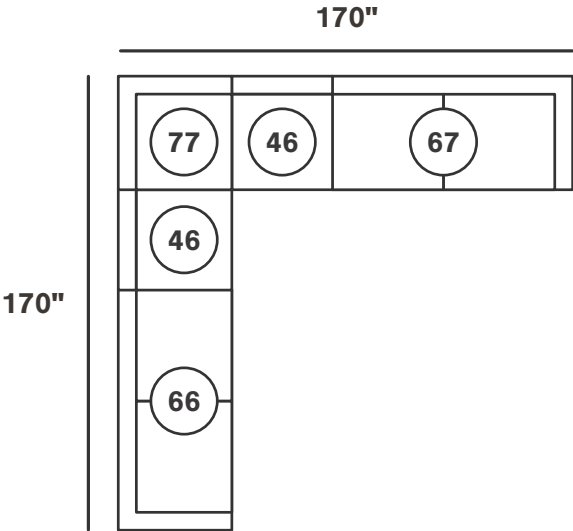
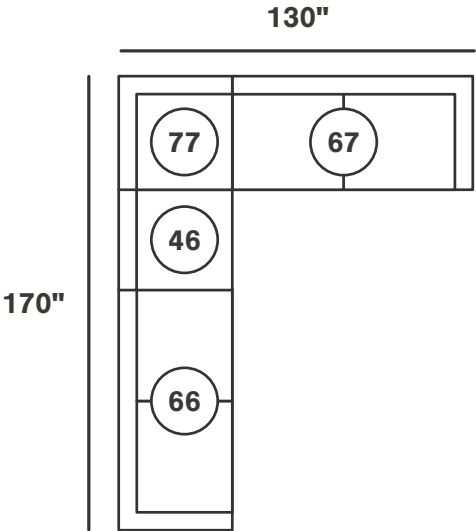
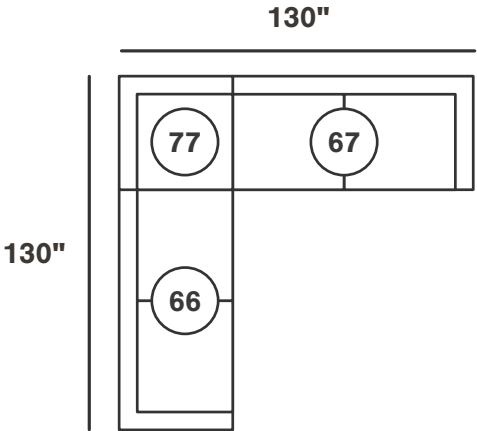

*All measurements are approximations.



bayless 523

INDIVIDUAL PIECES

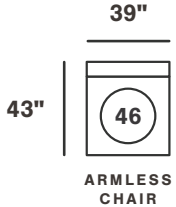
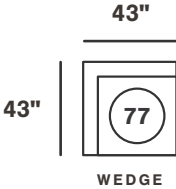
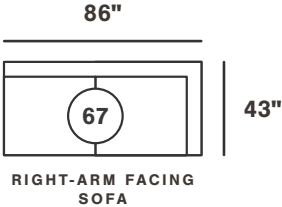
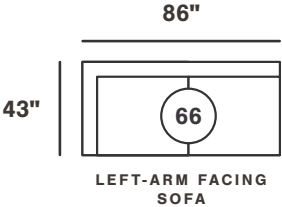

ADDITIONAL PIECES

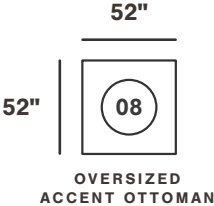

*All measurements are approximations.

bladen 120

OUR FAVORITE CONFIGURATIONS

Reverse configurations available.

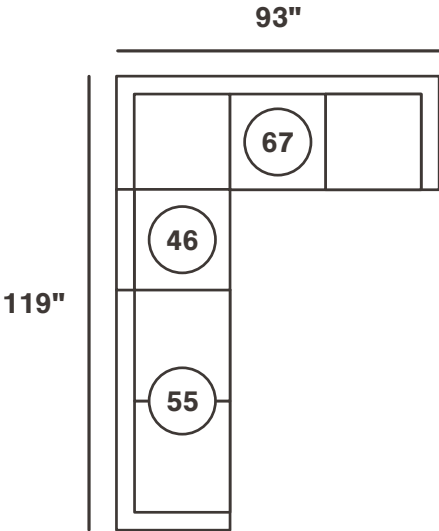
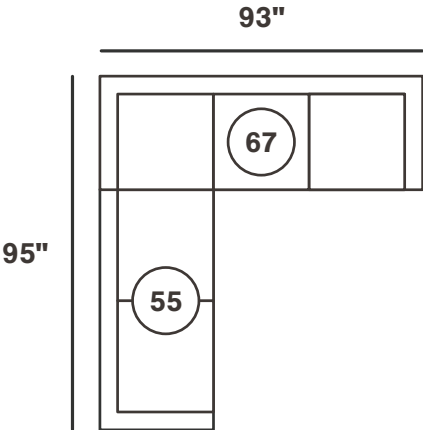

*All measurements are approximations.



bladen 120

INDIVIDUAL PIECES

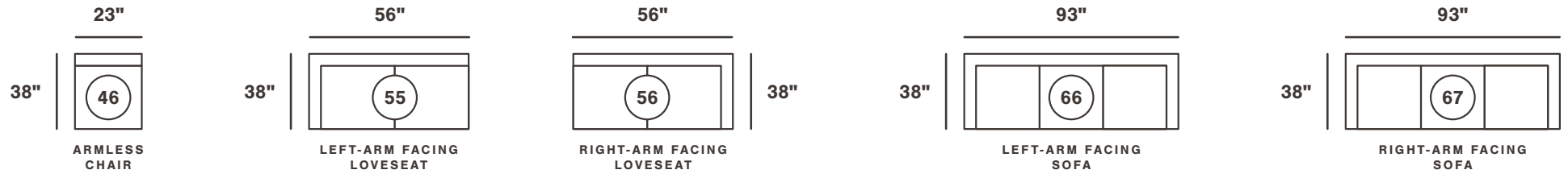

ADDITIONAL PIECES

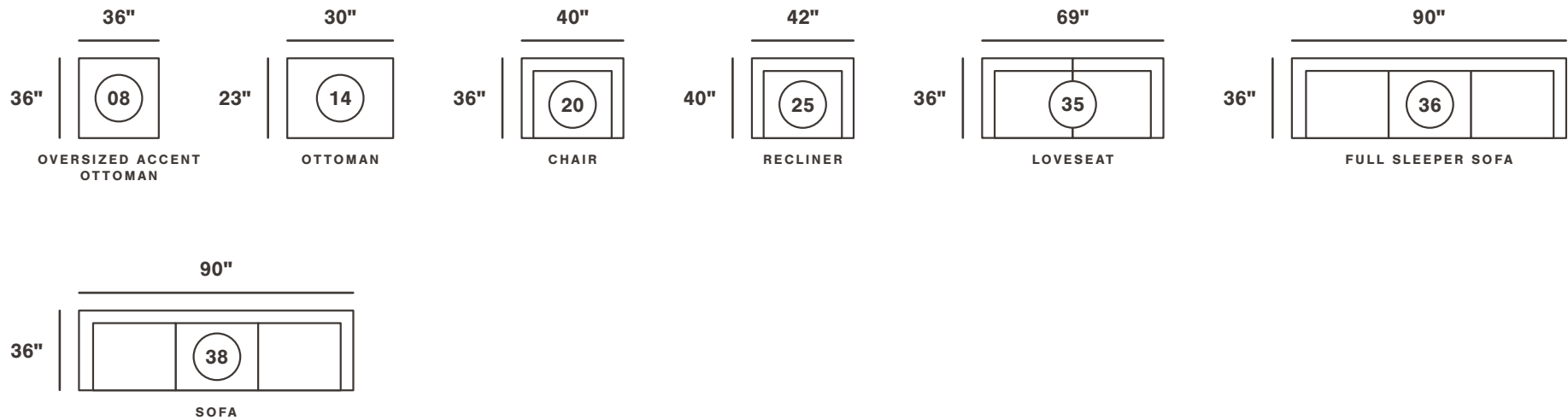

*All measurements are approximations.

bovarian 561

OUR FAVORITE CONFIGURATIONS

Reverse configurations available.

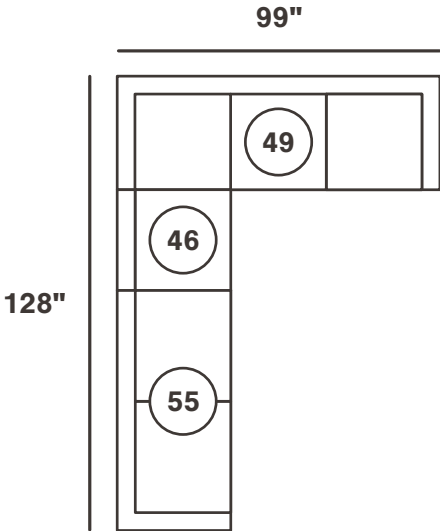
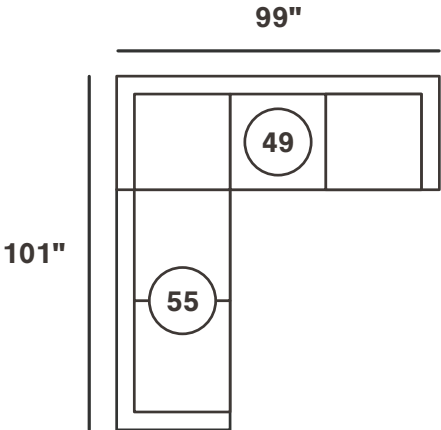

*All measurements are approximations.



bovarian 561

INDIVIDUAL PIECES

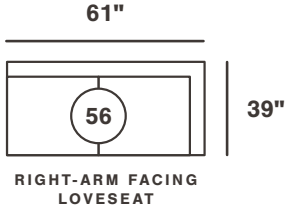
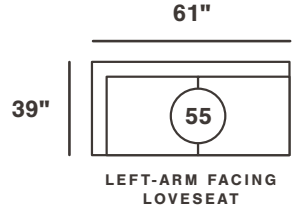
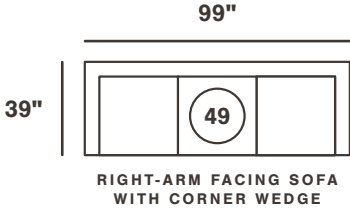
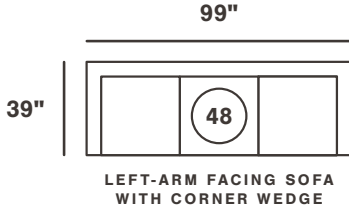

ADDITIONAL PIECES

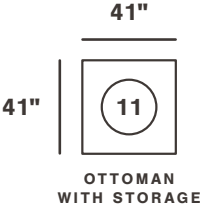

*All measurements are approximations.

carnaby 124

OUR FAVORITE CONFIGURATIONS

Reverse configurations available.

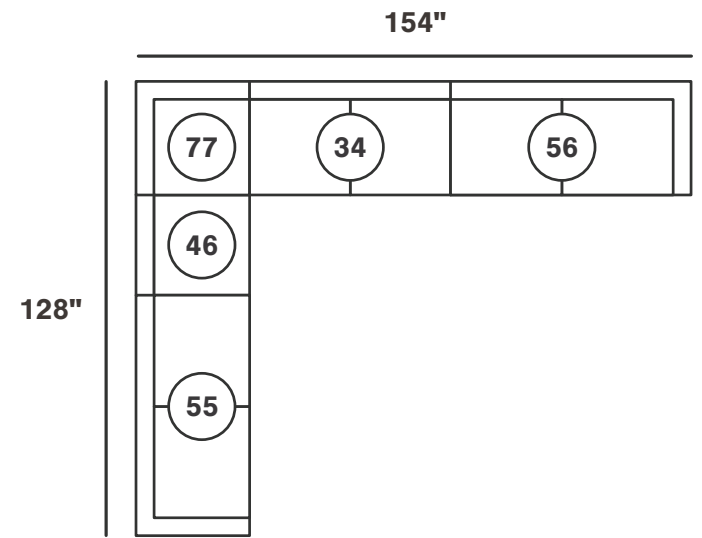
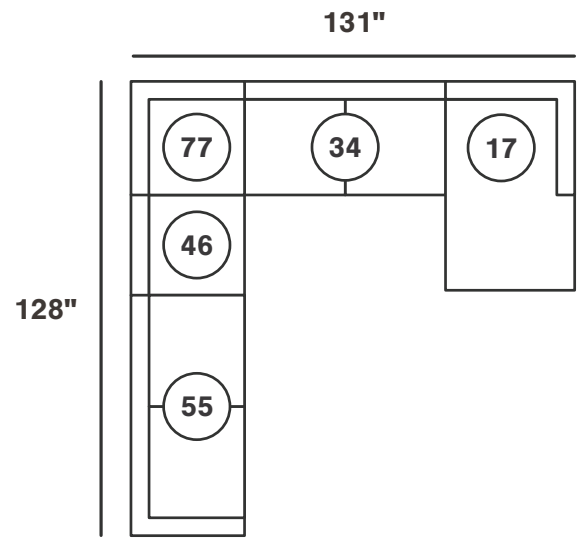
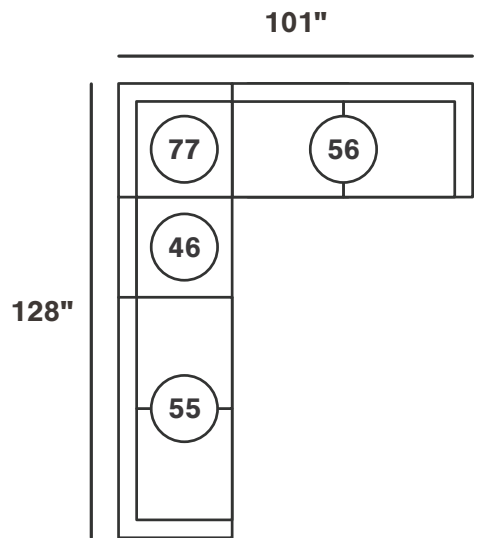
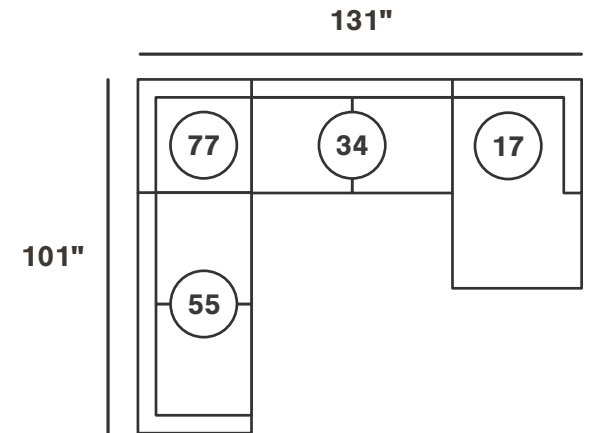
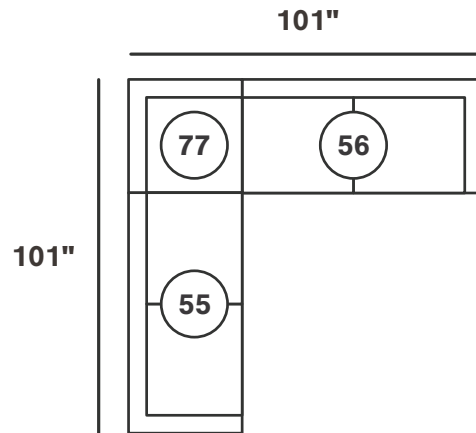
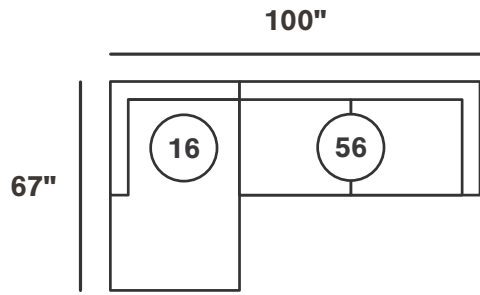

*All measurements are approximations.



INDIVIDUAL PIECES

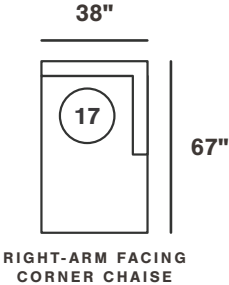
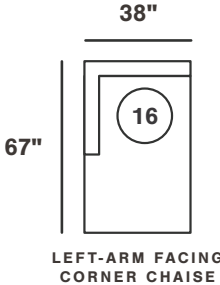
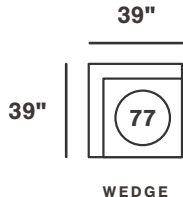
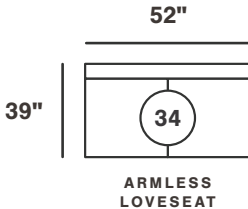
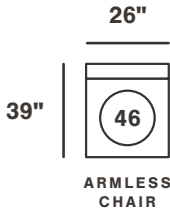
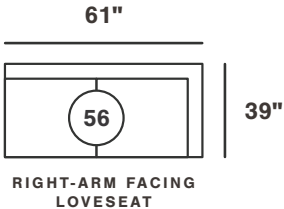
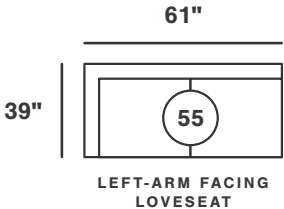

ADDITIONAL PIECES

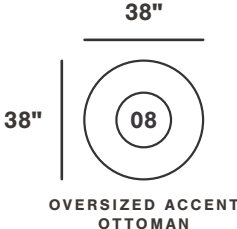

*All measurements are approximations.

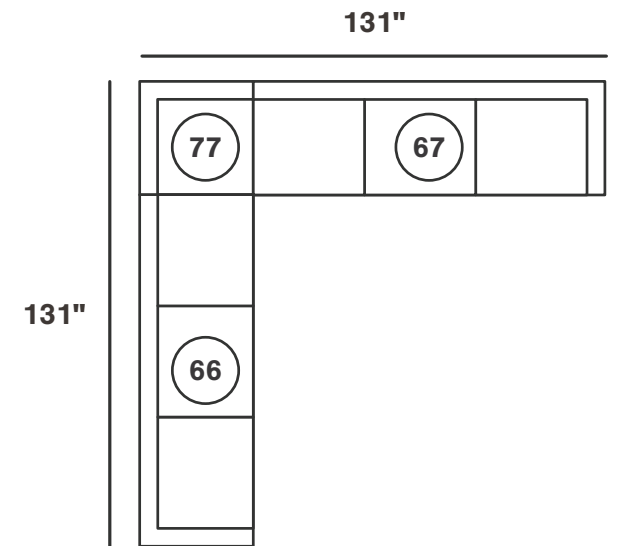
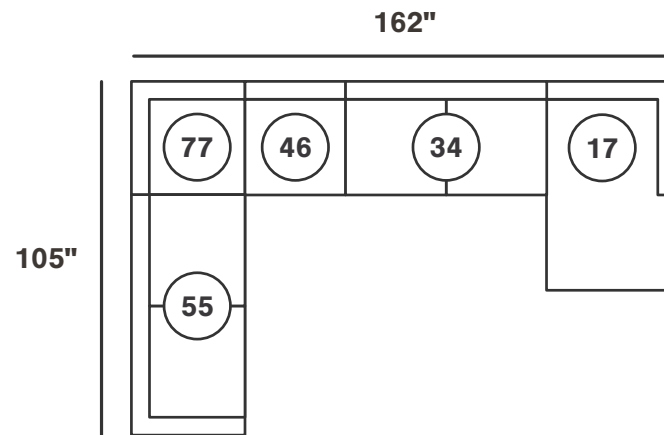
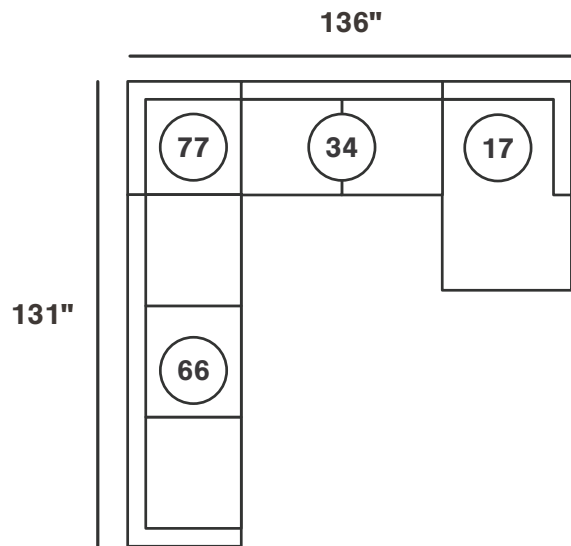
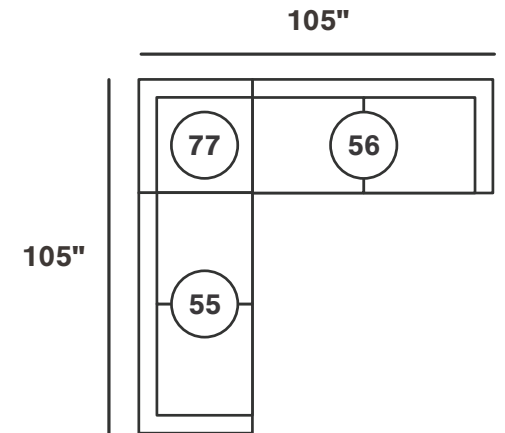
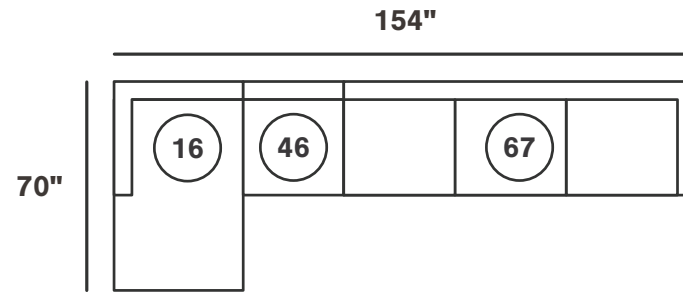
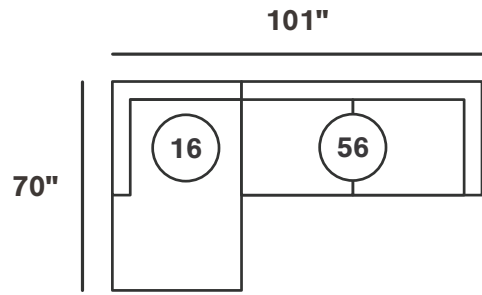

castano 133

INDIVIDUAL PIECES

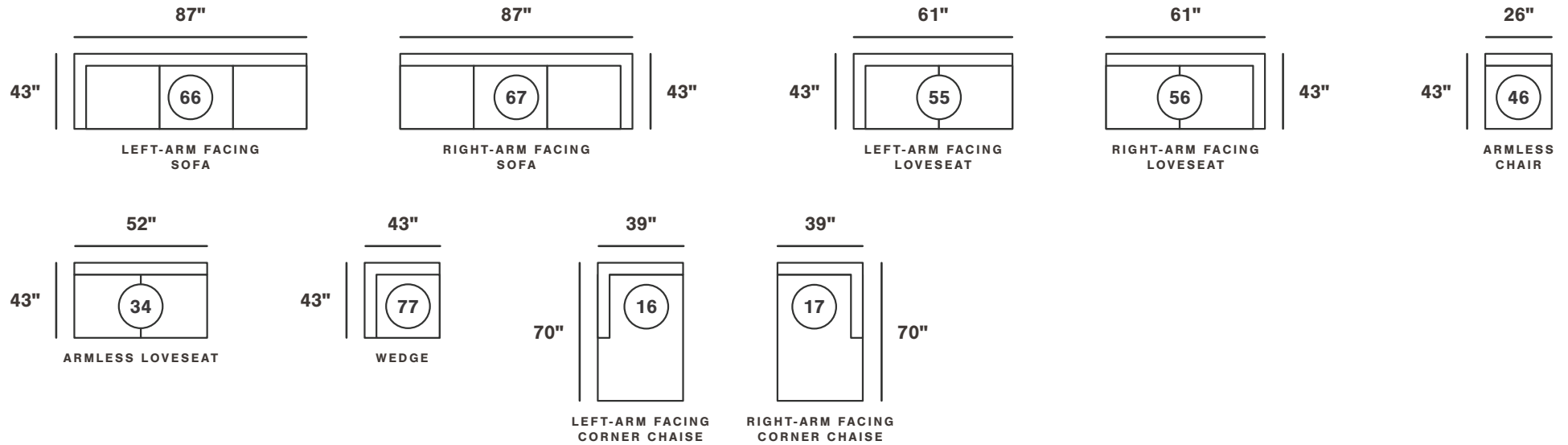

ADDITIONAL PIECES

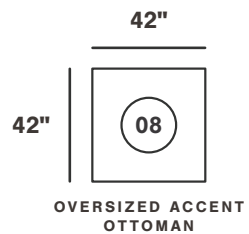

*All measurements are approximations.

coulee point 944

OUR FAVORITE CONFIGURATIONS

Reverse configurations available.

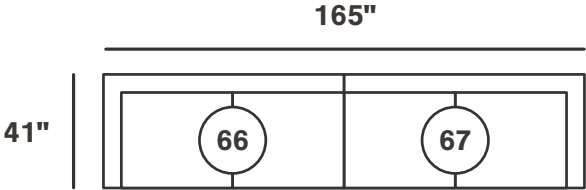
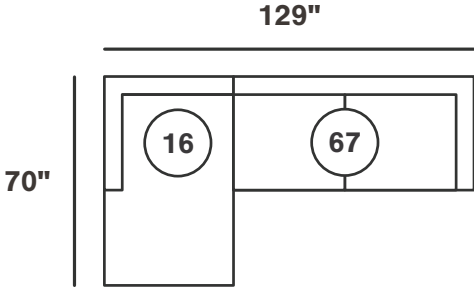

*All measurements are approximations.



coulee point 944

INDIVIDUAL PIECES

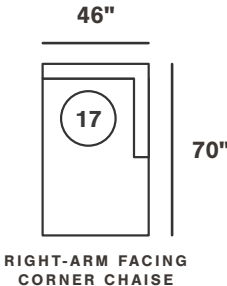
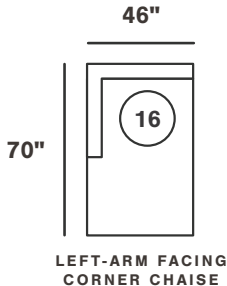
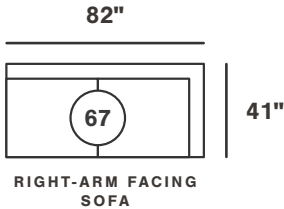
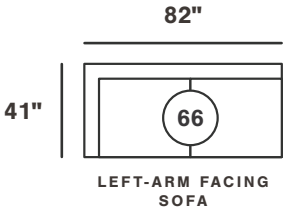

*All measurements are approximations.

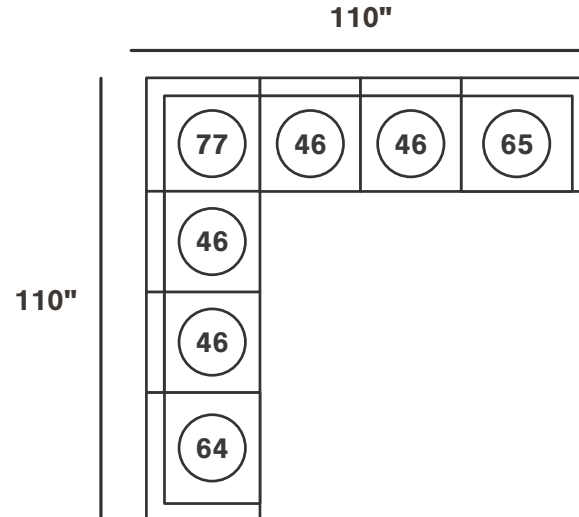
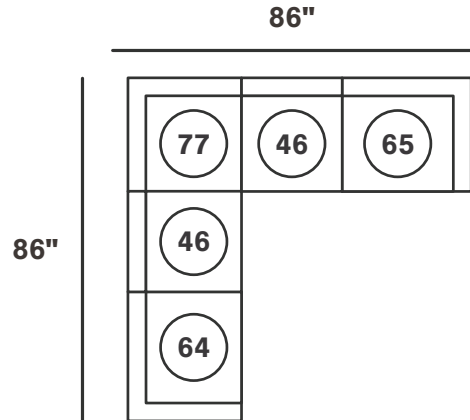
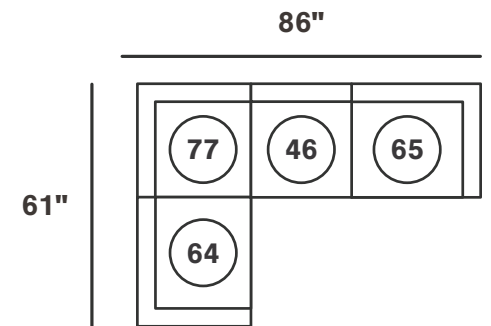
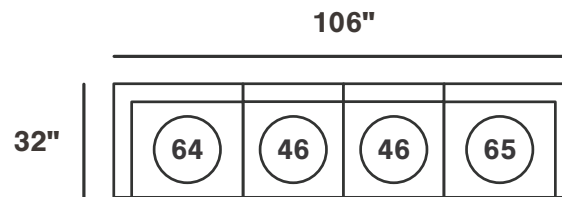
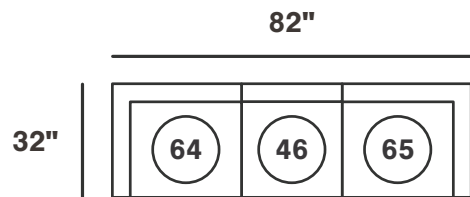

INDIVIDUAL PIECES

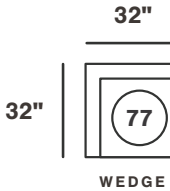
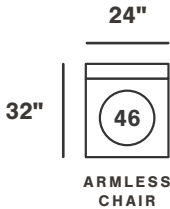
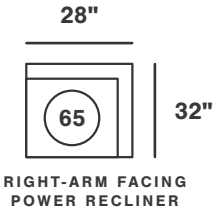
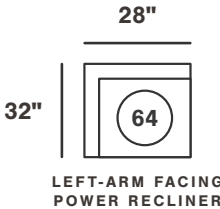

*All measurements are approximations.

eltmann 413

OUR FAVORITE CONFIGURATIONS

Reverse configurations available.

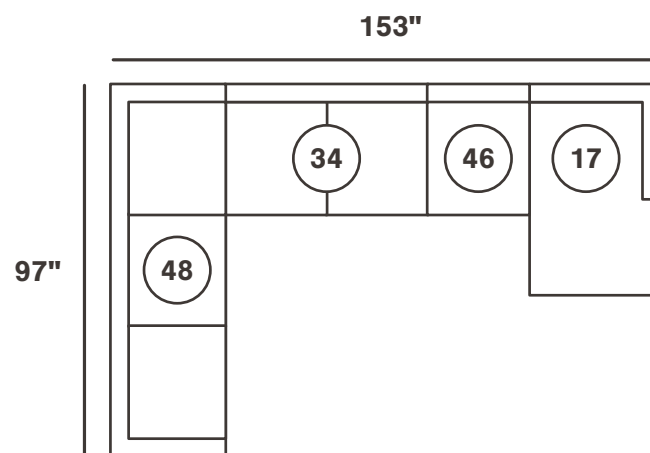
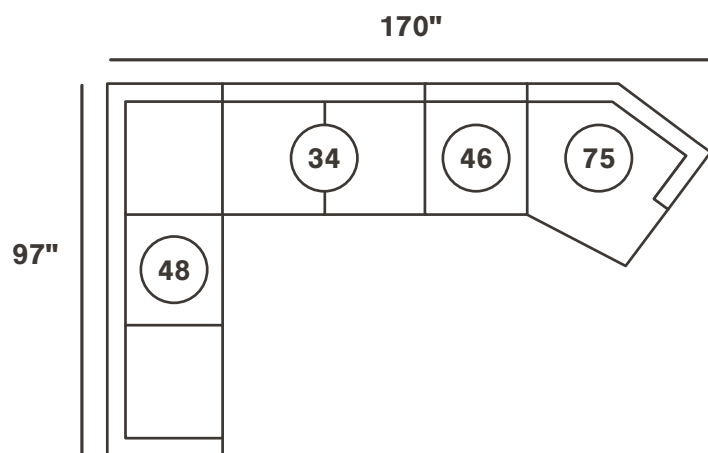
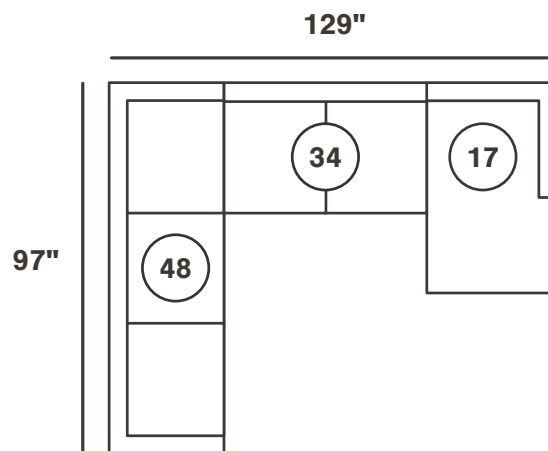
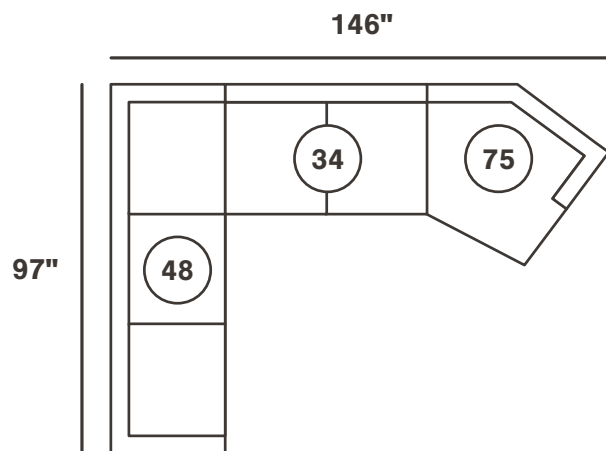

*All measurements are approximations.



eltmann 413

INDIVIDUAL PIECES

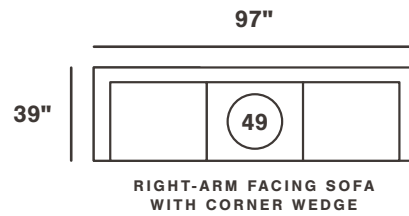
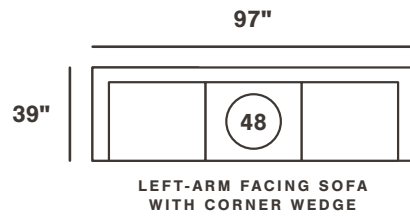
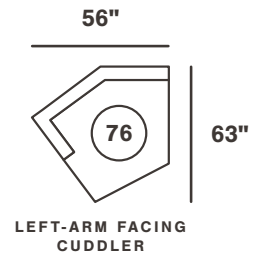
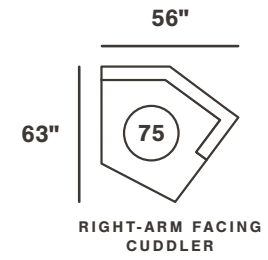
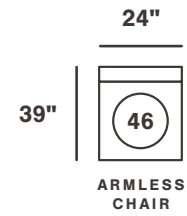
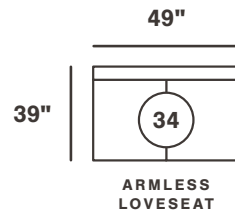
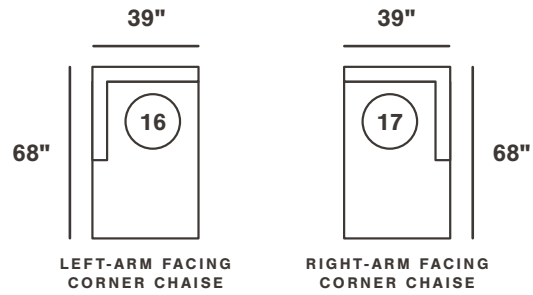

ADDITIONAL PIECES

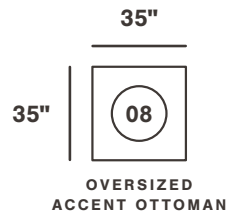

*All measurements are approximations.

emilia 309

OUR FAVORITE CONFIGURATIONS

Reverse configurations available.

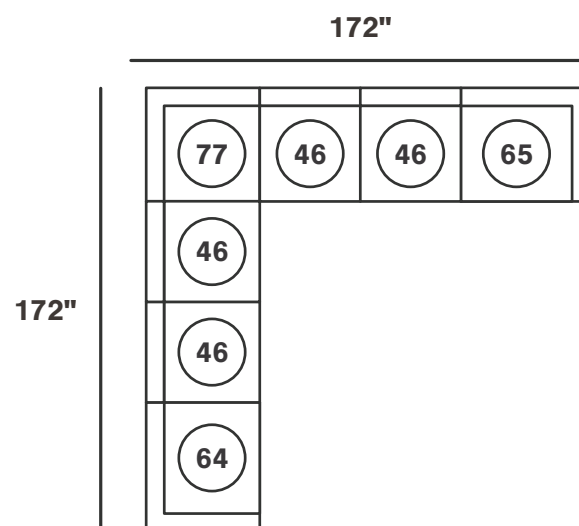
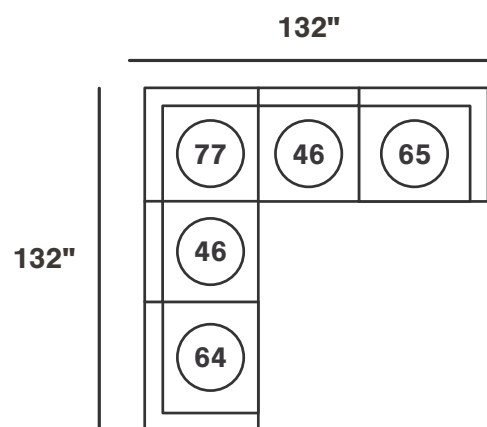
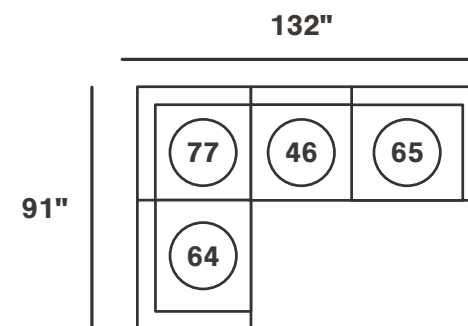
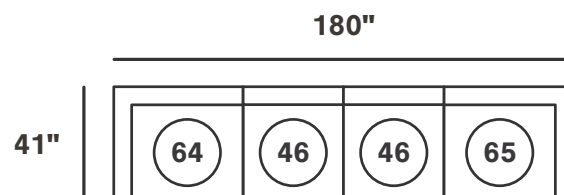
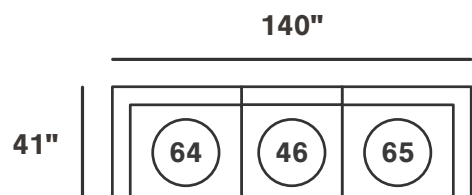

*All measurements are approximations.



emilia 309

INDIVIDUAL PIECES

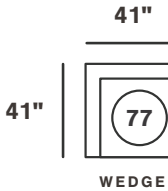
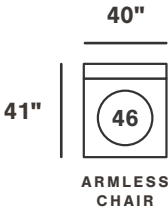
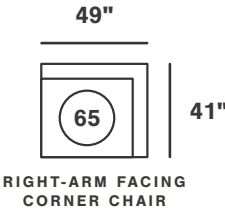
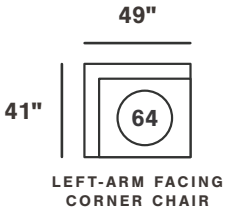

ADDITIONAL PIECES

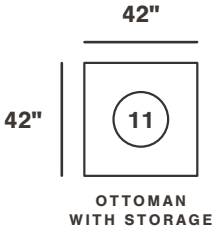

*All measurements are approximations.

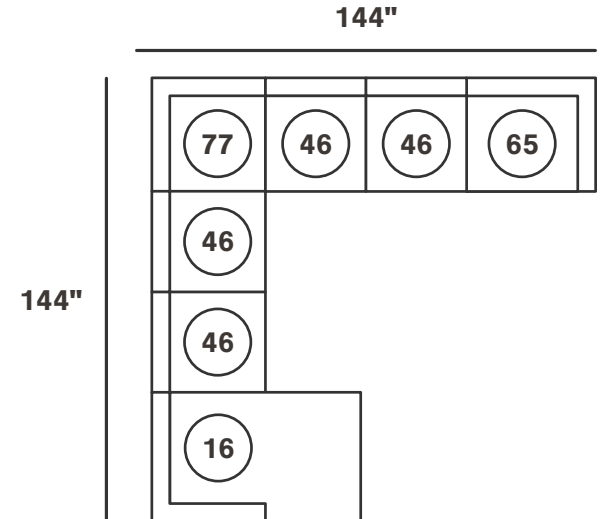
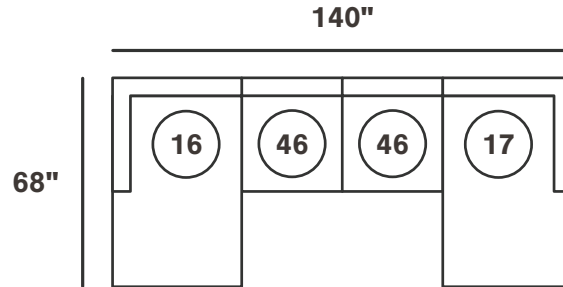
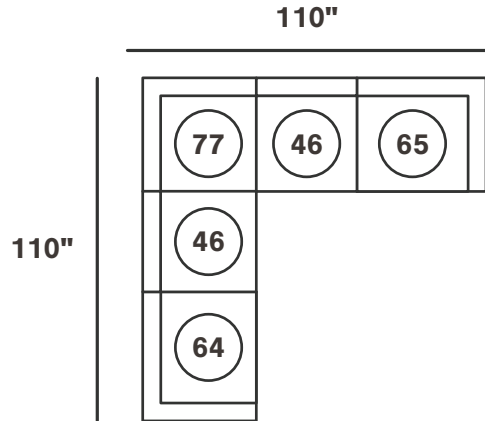
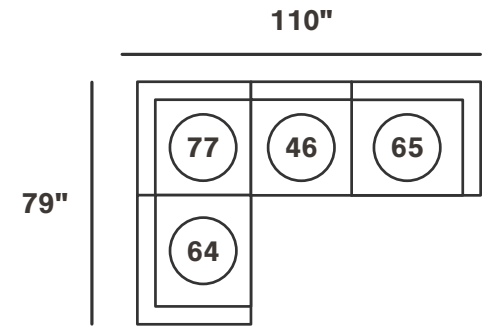
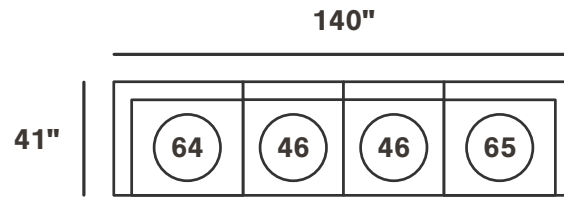
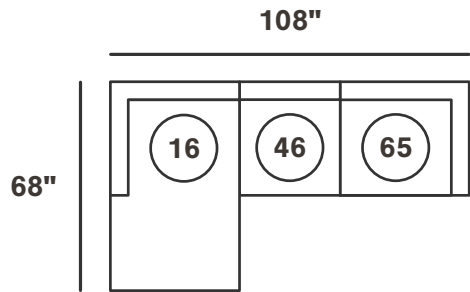

INDIVIDUAL PIECES

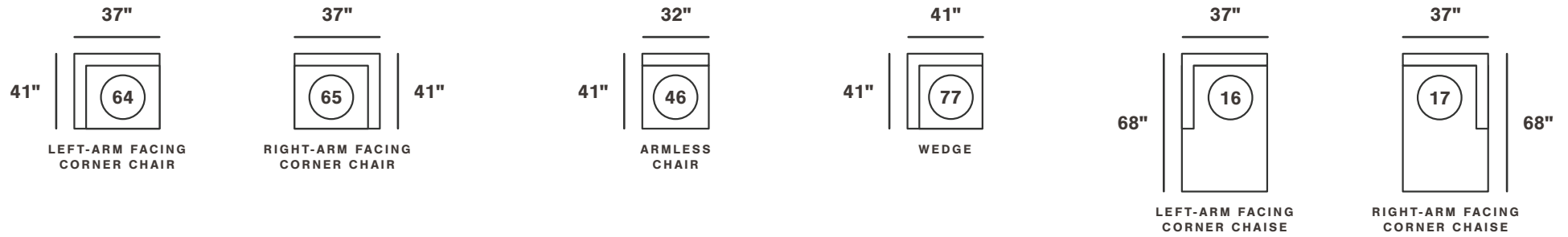

ADDITIONAL PIECES

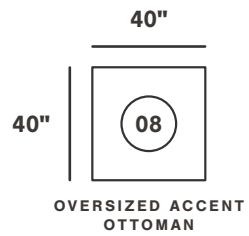

gimma 160

OUR FAVORITE CONFIGURATIONS

Reverse configurations available.

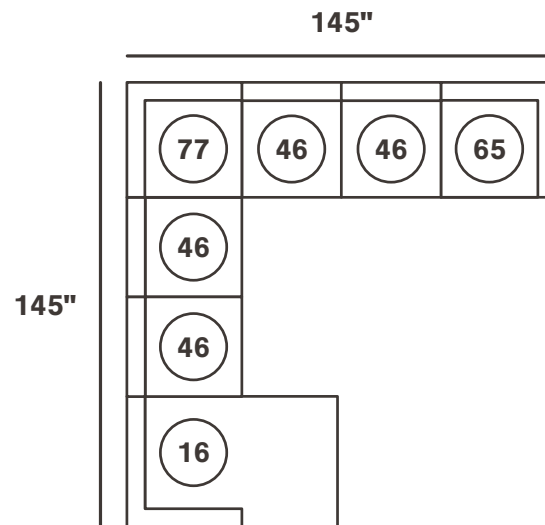
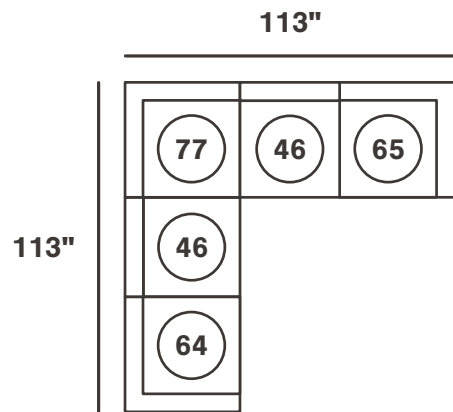
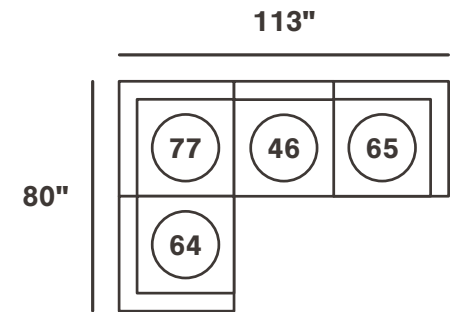
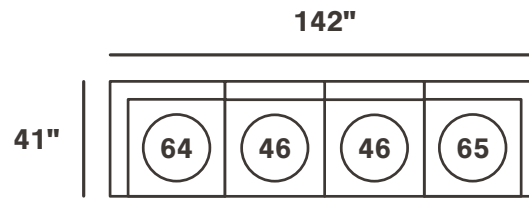
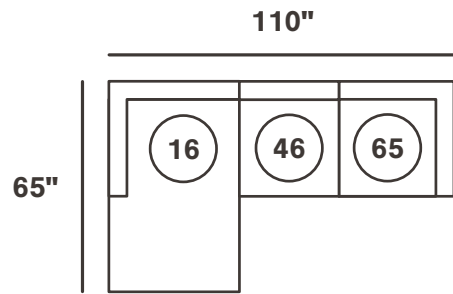

*All measurements are approximations.



gimma 160

INDIVIDUAL PIECES

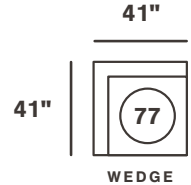
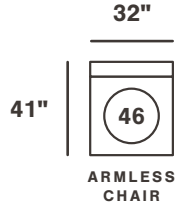
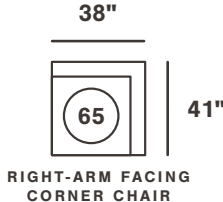
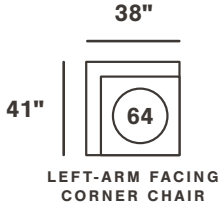
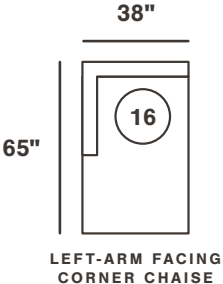

ADDITIONAL PIECES

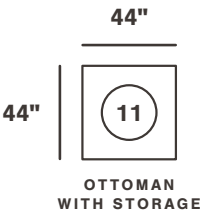

*All measurements are approximations.

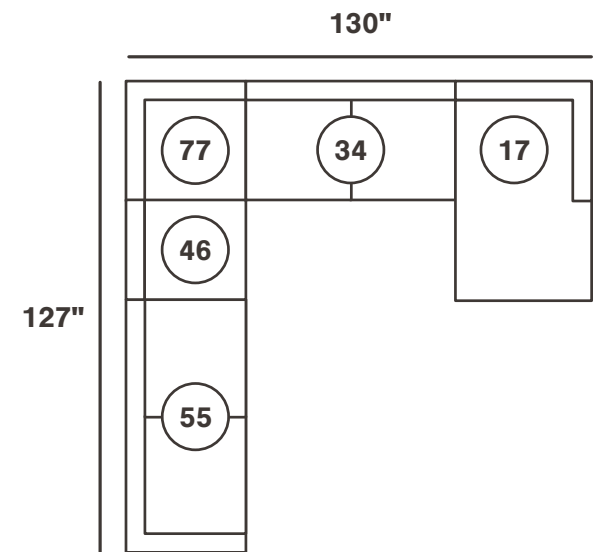
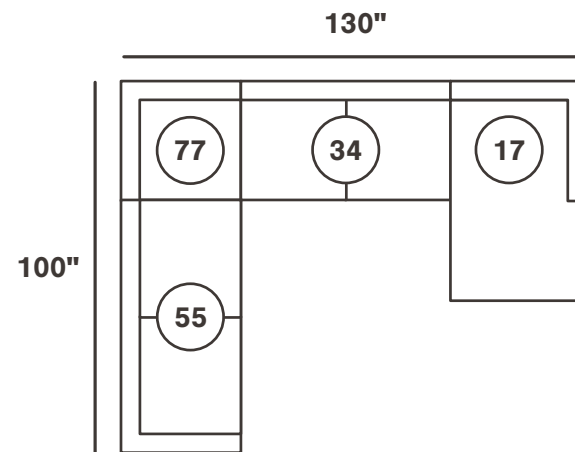
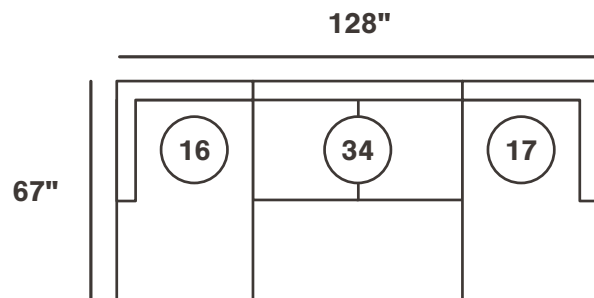
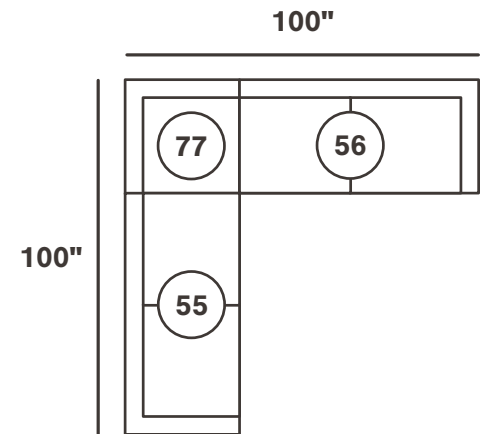
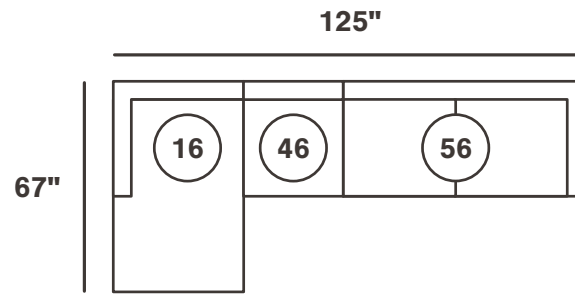
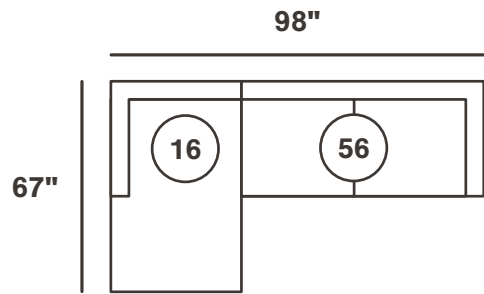

keener 110

INDIVIDUAL PIECES

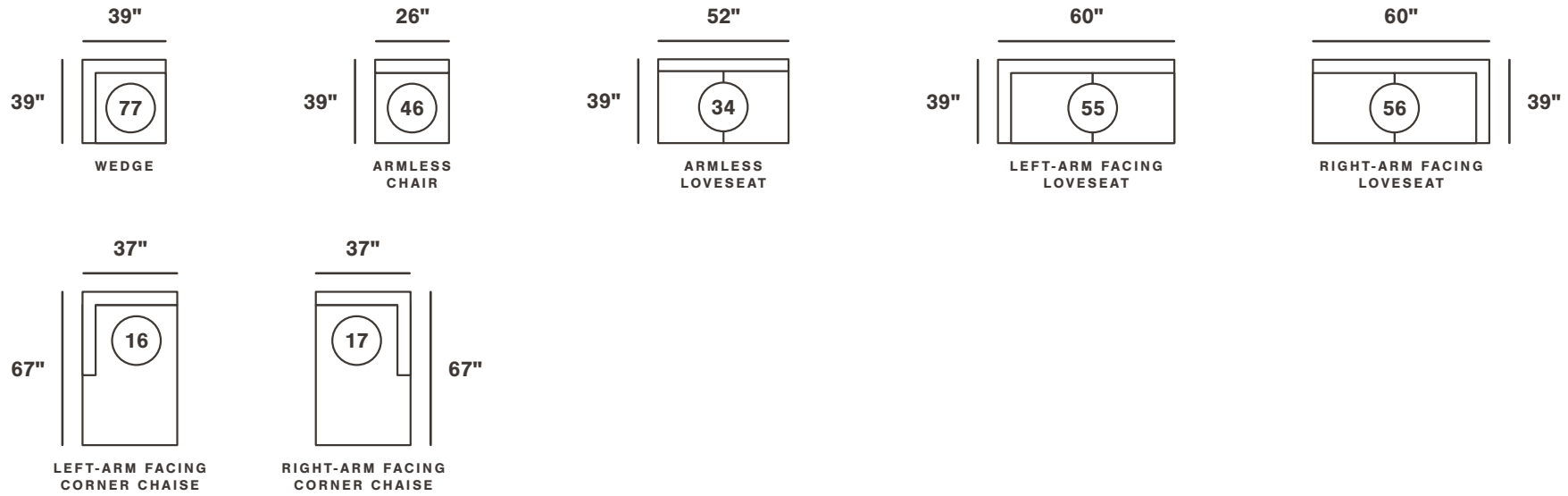

ADDITIONAL PIECES

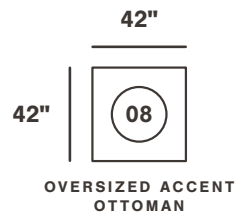

*All measurements are approximations.

larce 502

OUR FAVORITE CONFIGURATIONS

Reverse configurations available.

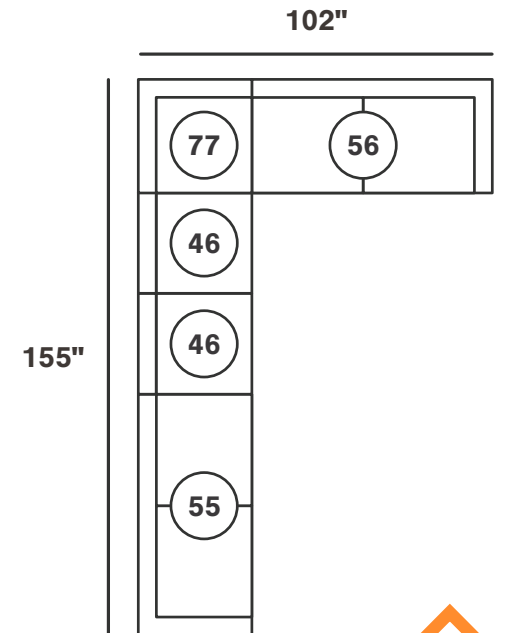
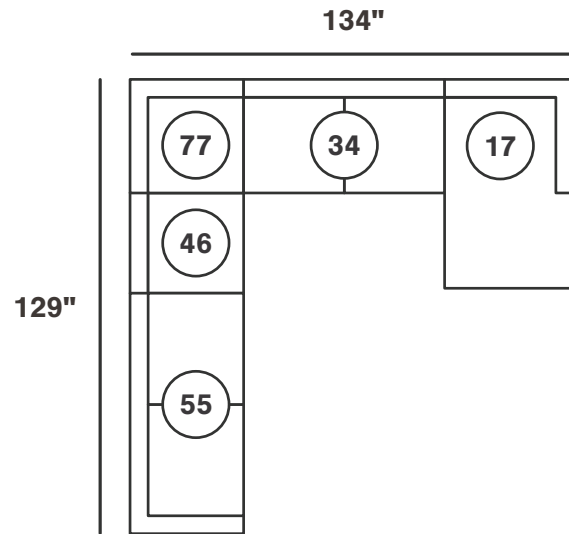
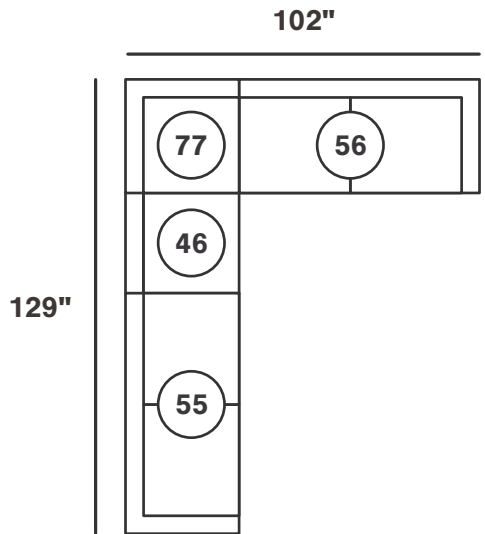
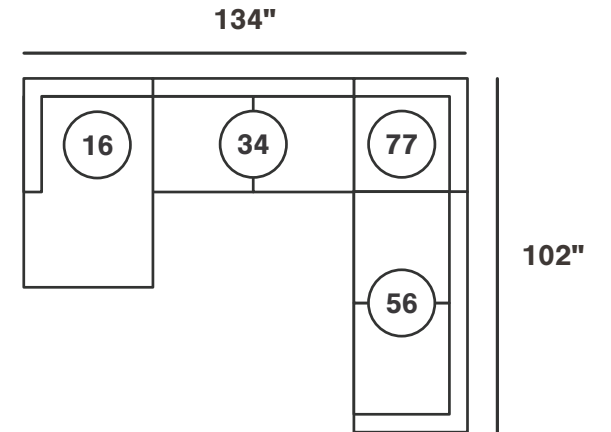
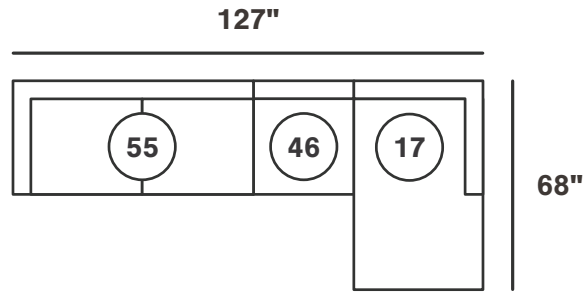
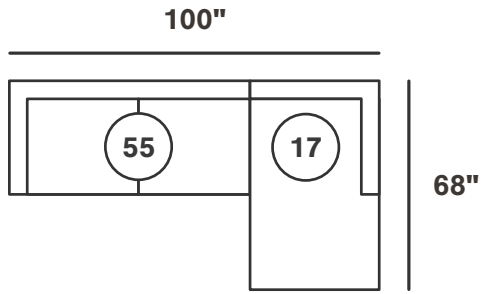

*All measurements are approximations.



larce 502

INDIVIDUAL PIECES

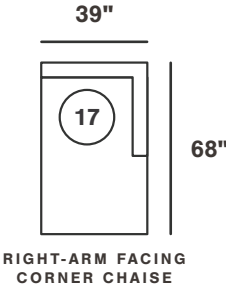
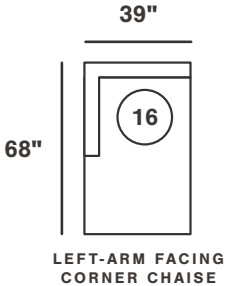
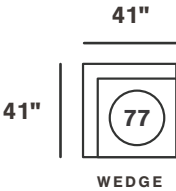
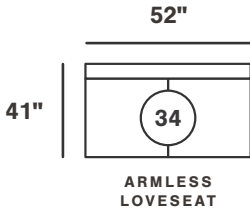
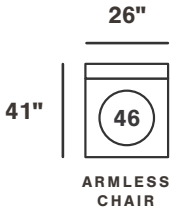
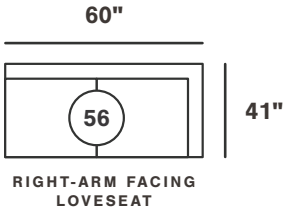
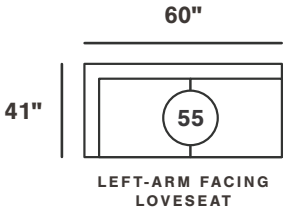

ADDITIONAL PIECES

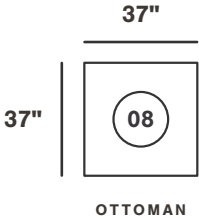

*All measurements are approximations.

lavernett 596

OUR FAVORITE CONFIGURATIONS

Reverse configurations available.

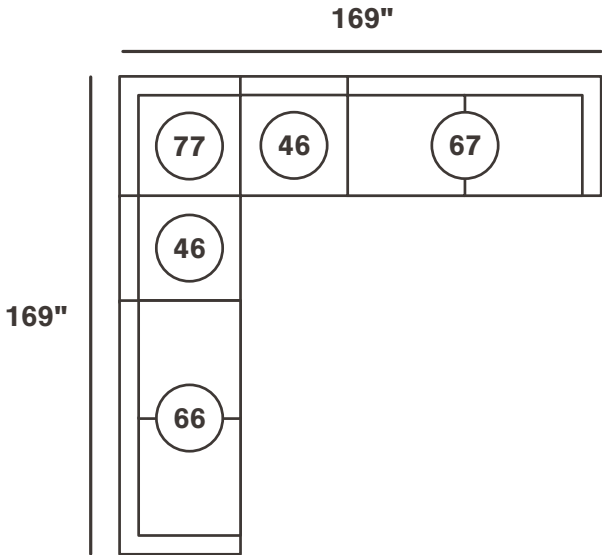
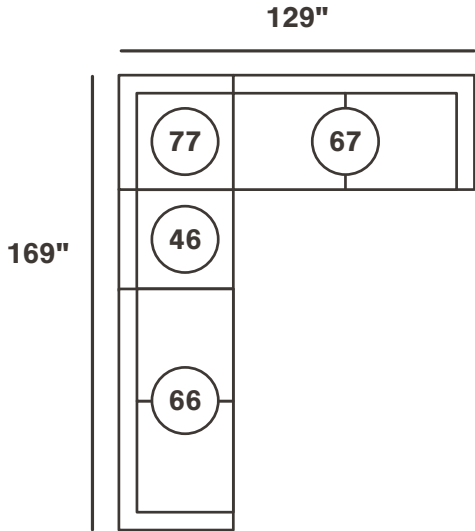
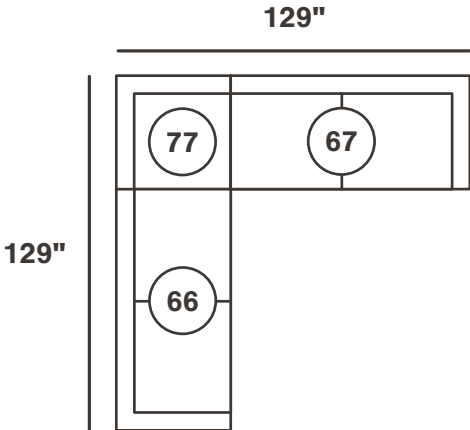
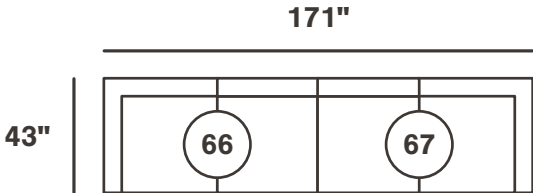

*All measurements are approximations.



lavernett 596

INDIVIDUAL PIECES

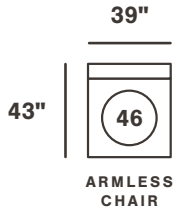
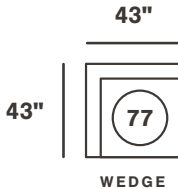
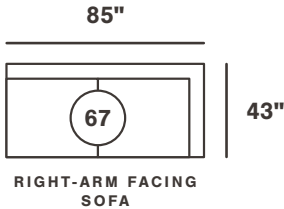
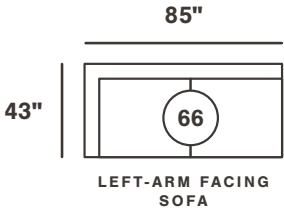

ADDITIONAL PIECES

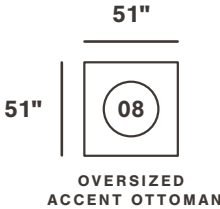

*All measurements are approximations.

Ierenza 403

OUR FAVORITE CONFIGURATIONS

Reverse configurations available.

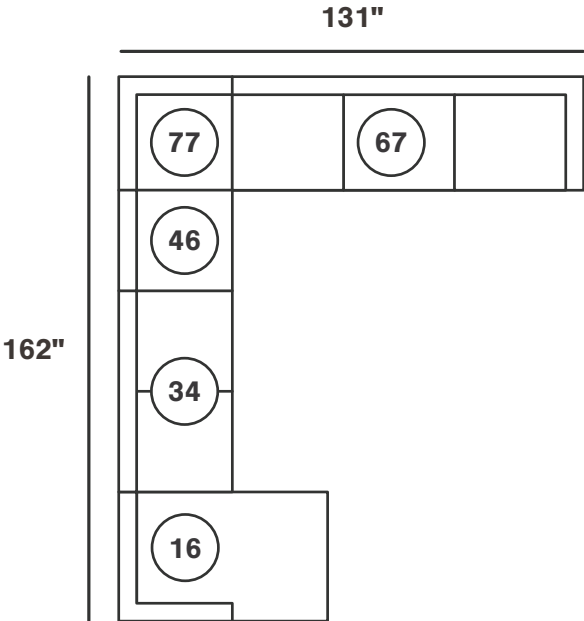
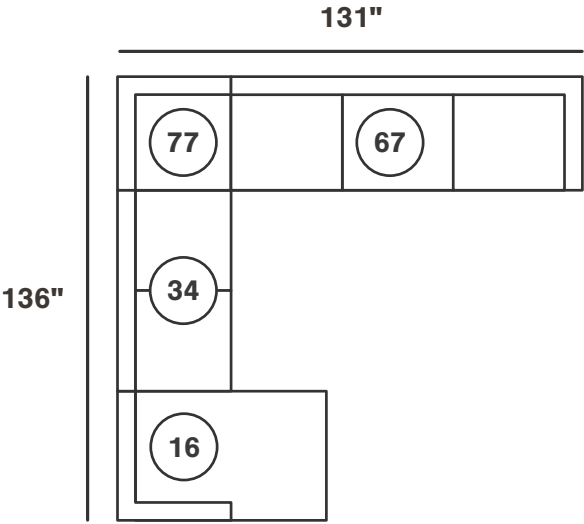
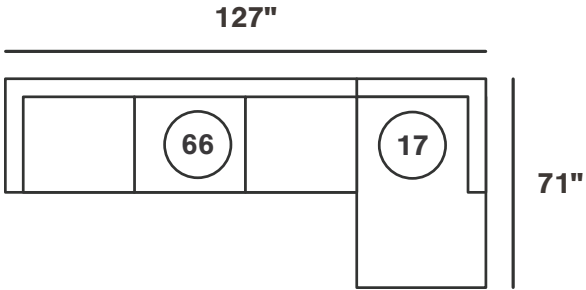

*All measurements are approximations.



Ierenza 403

INDIVIDUAL PIECES

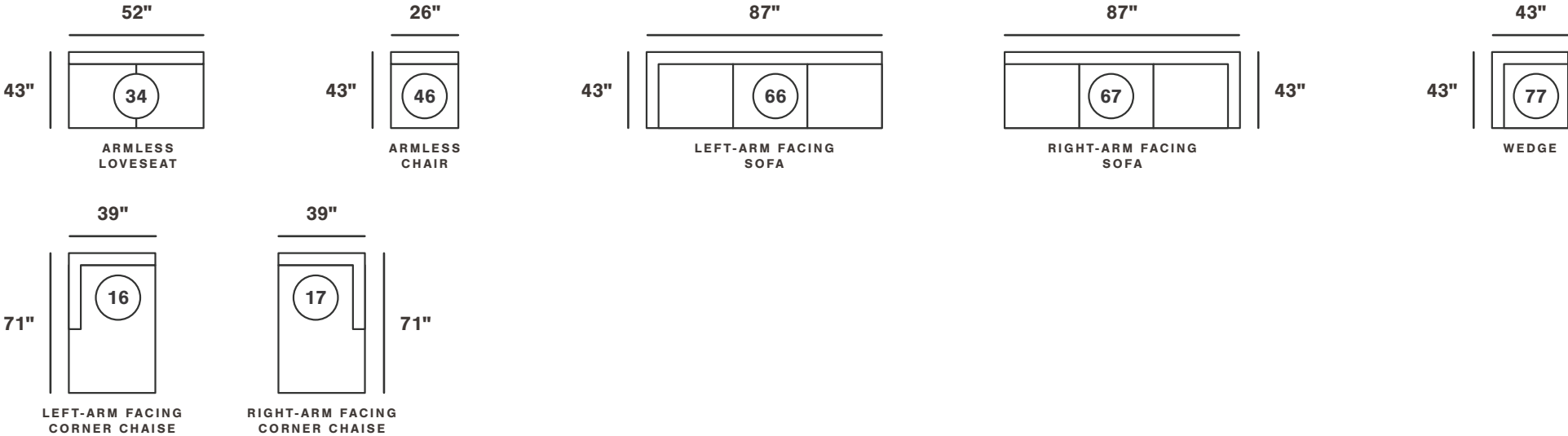

ADDITIONAL PIECES

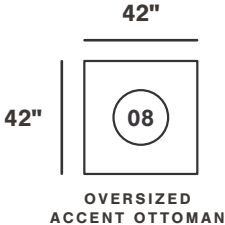

*All measurements are approximations.

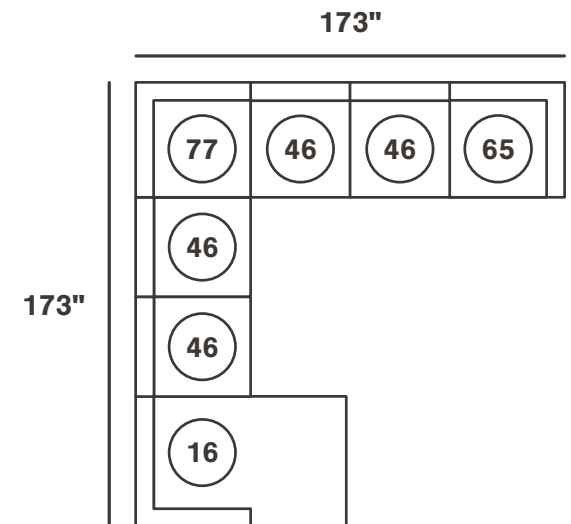
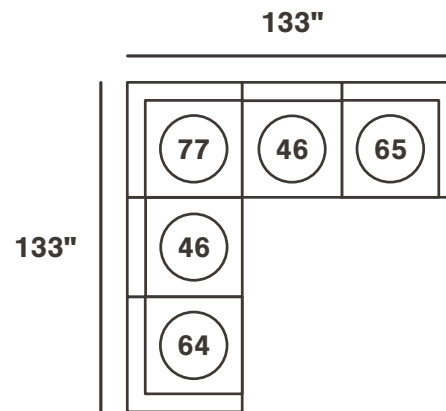
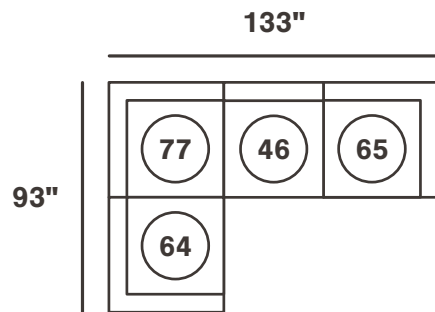
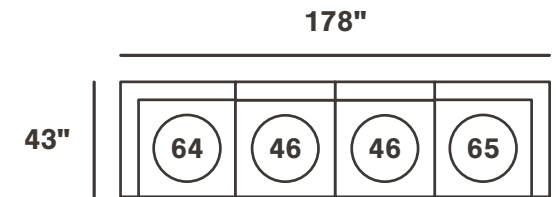
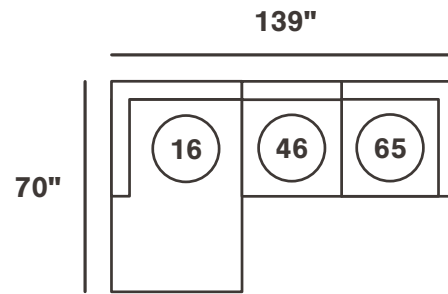
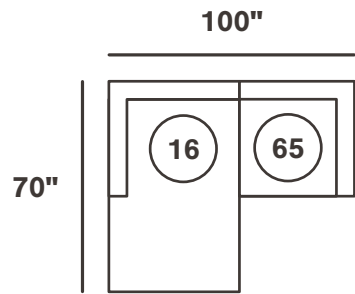

lindyn 211

INDIVIDUAL PIECES

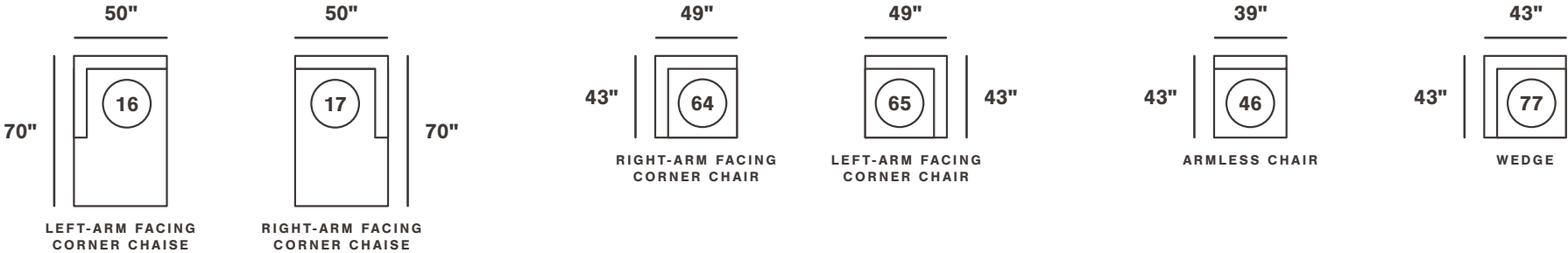

ADDITIONAL PIECES

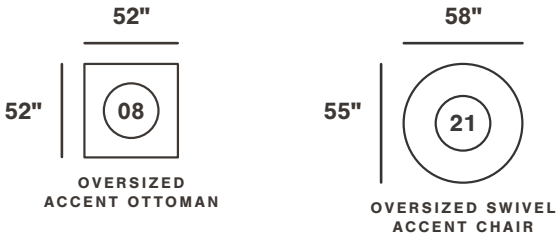

*All measurements are approximations.

Lucina 590

OUR FAVORITE CONFIGURATIONS

Reverse configurations available.

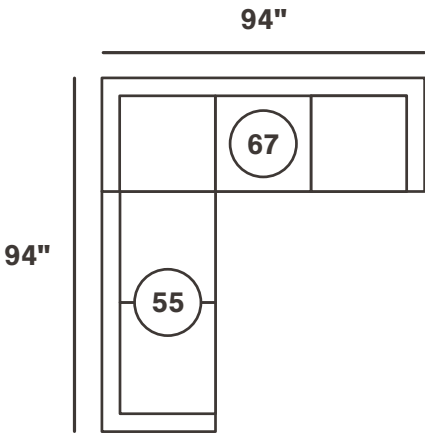
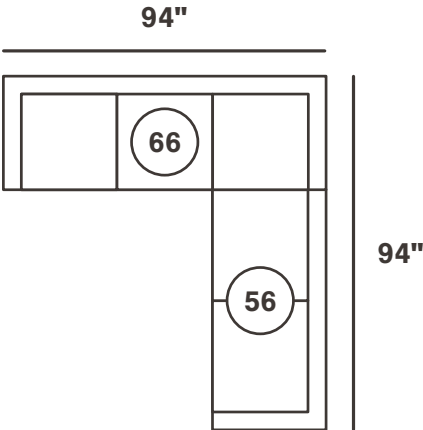
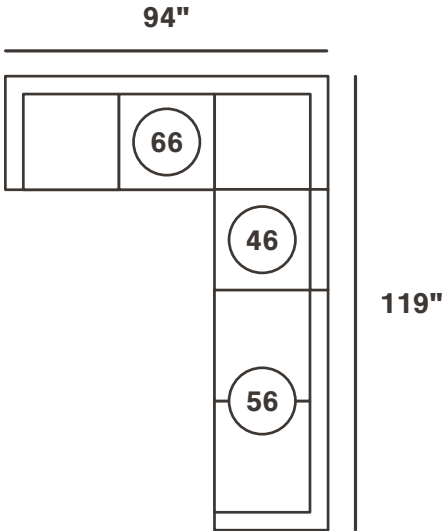
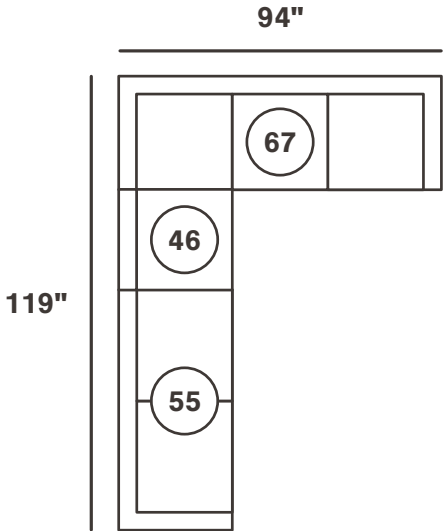

*All measurements are approximations.



Lucina 590

INDIVIDUAL PIECES

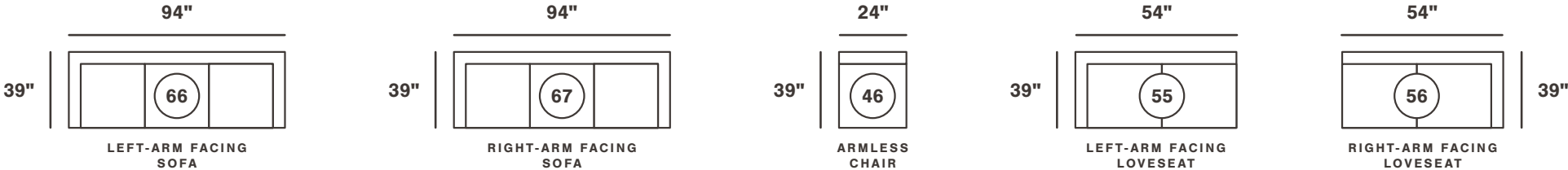

ADDITIONAL PIECES

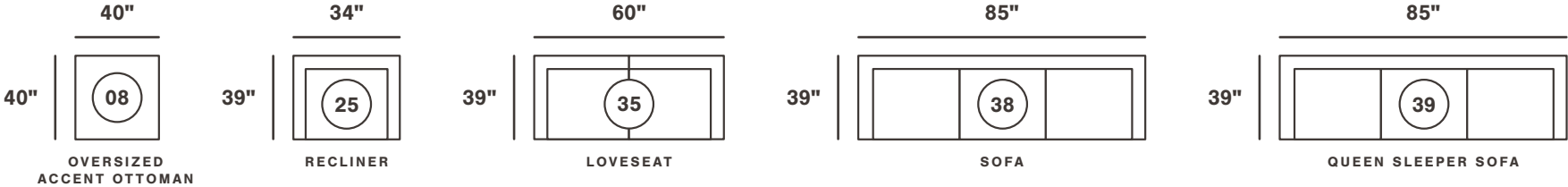

*All measurements are approximations.

luxora 525

OUR FAVORITE CONFIGURATIONS

Reverse configurations available.

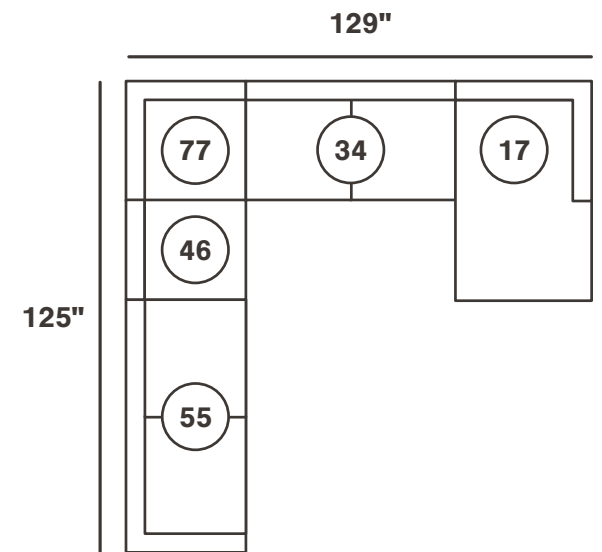
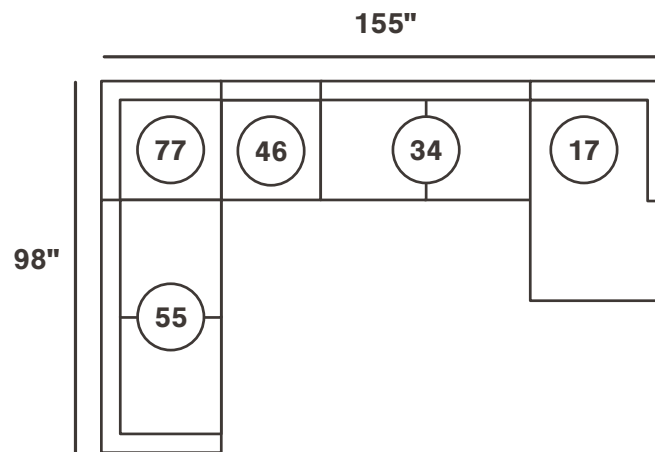
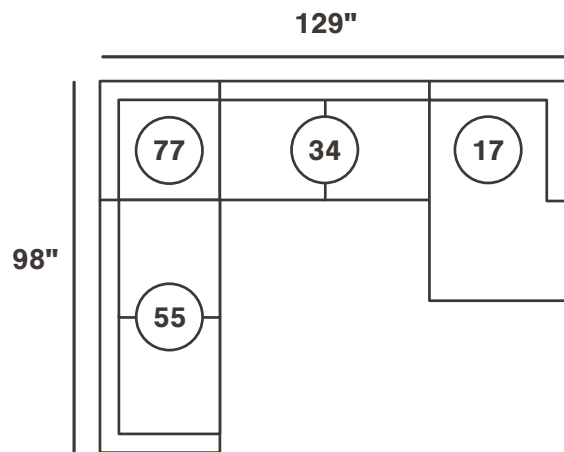
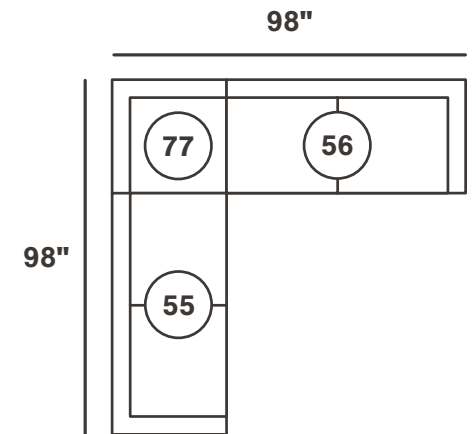
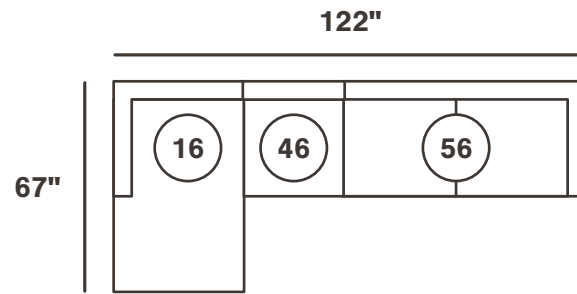
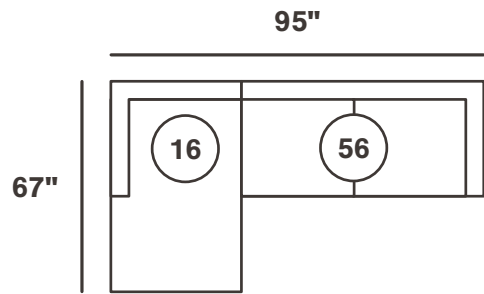

*All measurements are approximations.



luxora 525

INDIVIDUAL PIECES

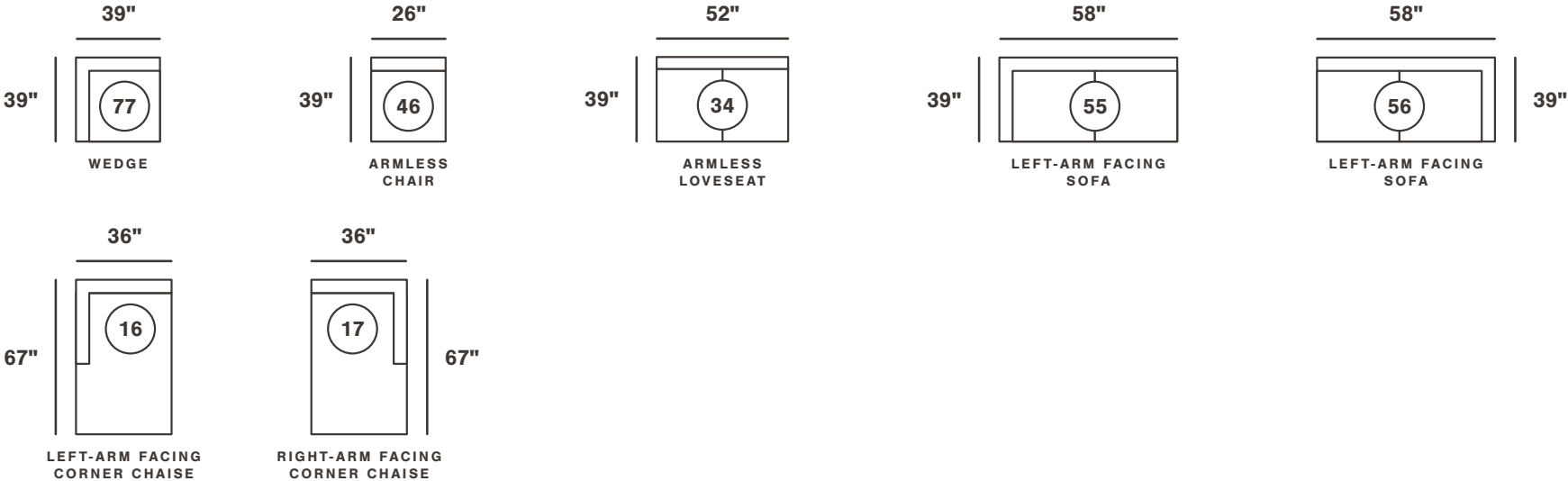

ADDITIONAL PIECES

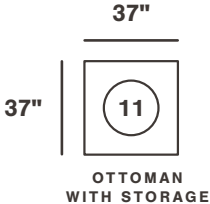

*All measurements are approximations.

lyndeboro 102

OUR FAVORITE CONFIGURATIONS

Reverse configurations available.

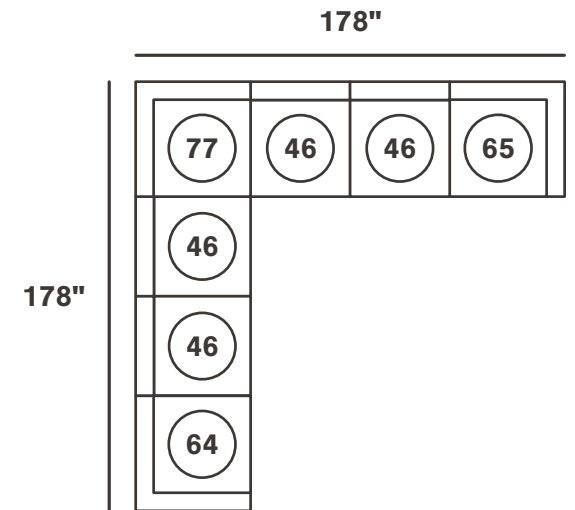
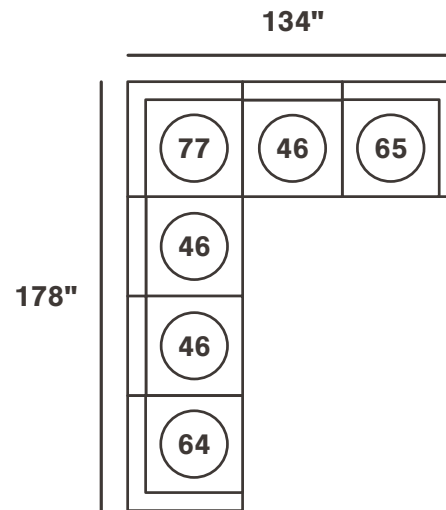
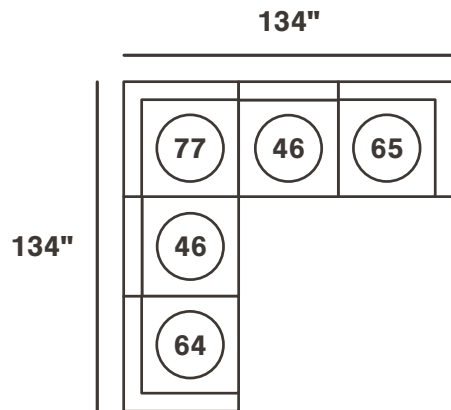
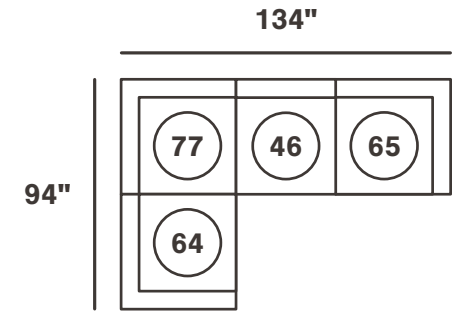
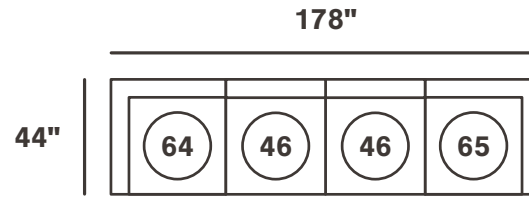
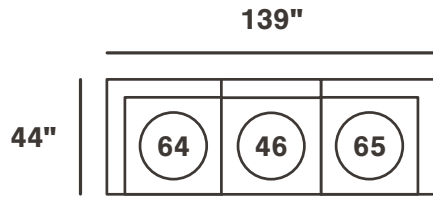

*All measurements are approximations.



lyndeboro 102

INDIVIDUAL PIECES

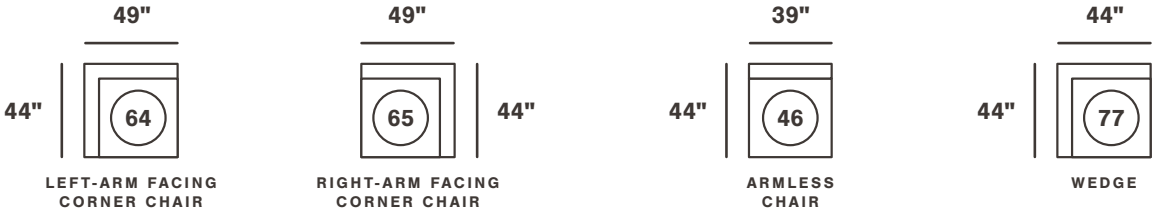

ADDITIONAL PIECES

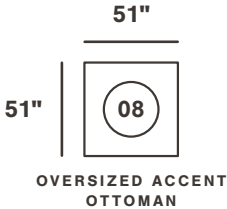

*All measurements are approximations.

navi 940

OUR FAVORITE CONFIGURATIONS

Reverse configurations available.

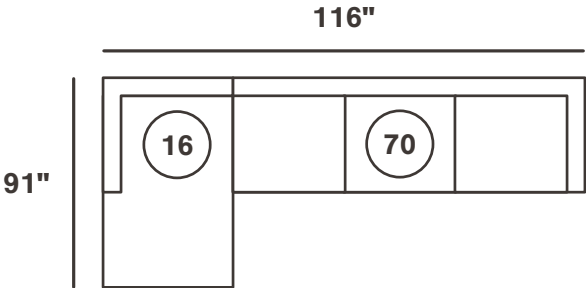
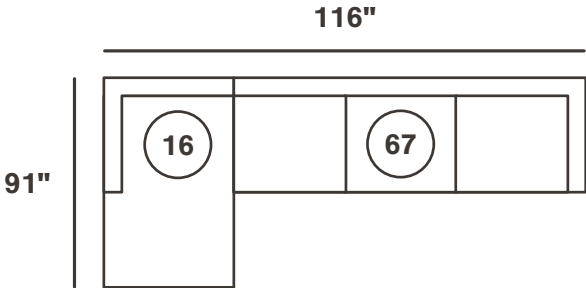

*All measurements are approximations.



navi 940

INDIVIDUAL PIECES

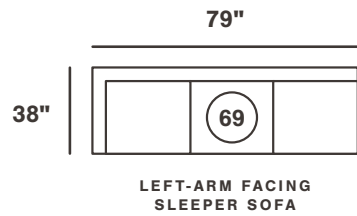
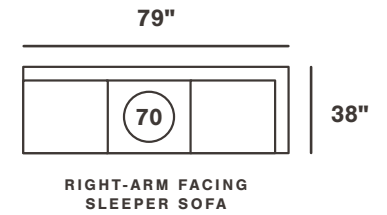
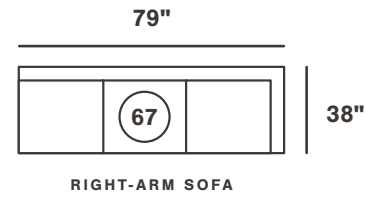
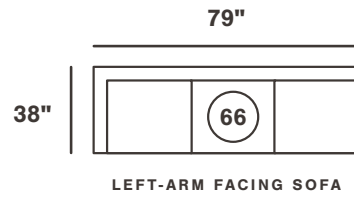
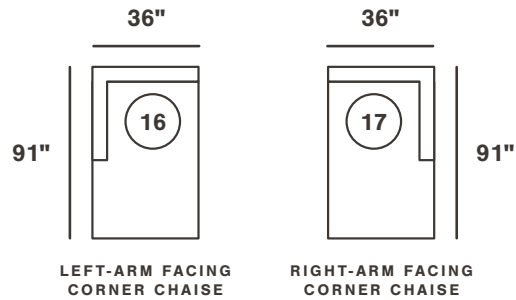

ADDITIONAL PIECES

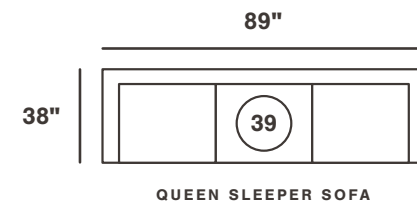
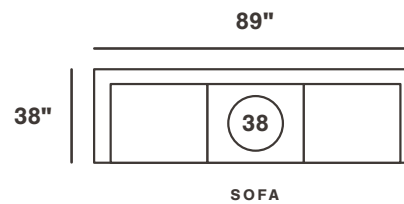
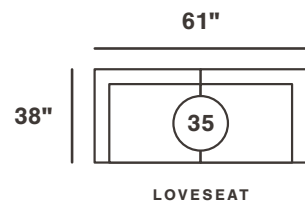
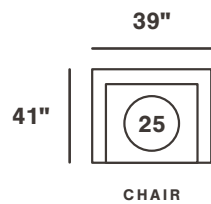
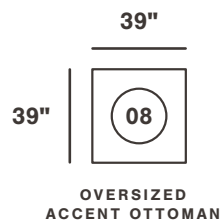

next-gen gaucho 154

OUR FAVORITE CONFIGURATIONS

Reverse configurations available.

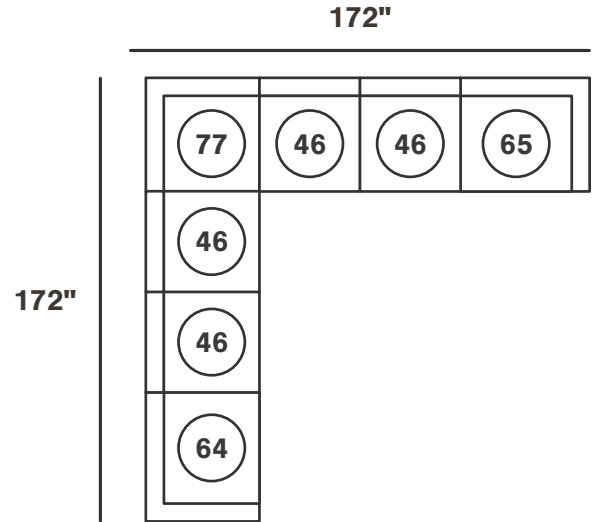
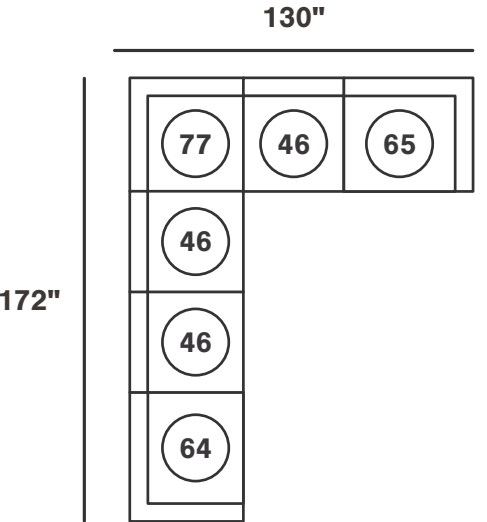
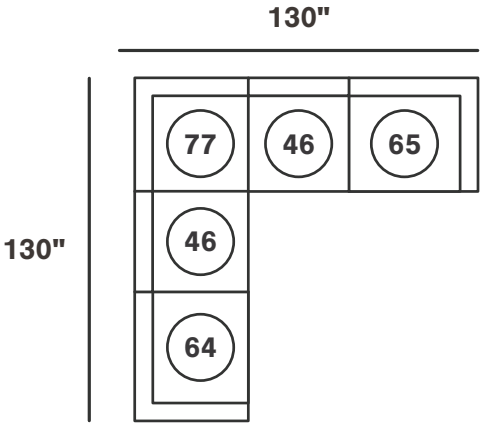
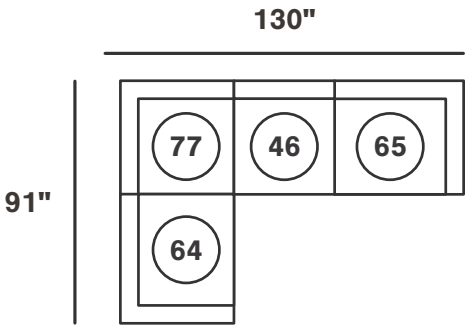
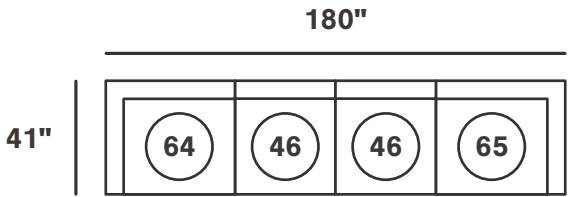
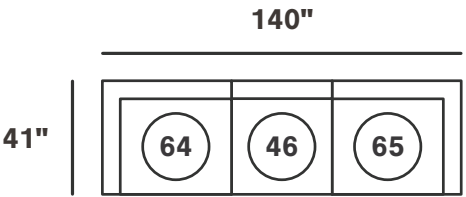

*All measurements are approximations.



next-gen gaucho 154

INDIVIDUAL PIECES

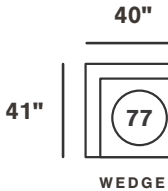
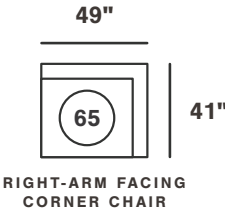
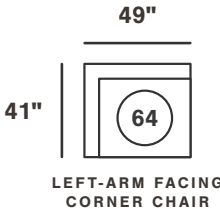

ADDITIONAL PIECES

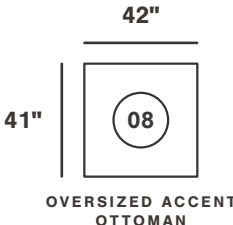

*All measurements are approximations.

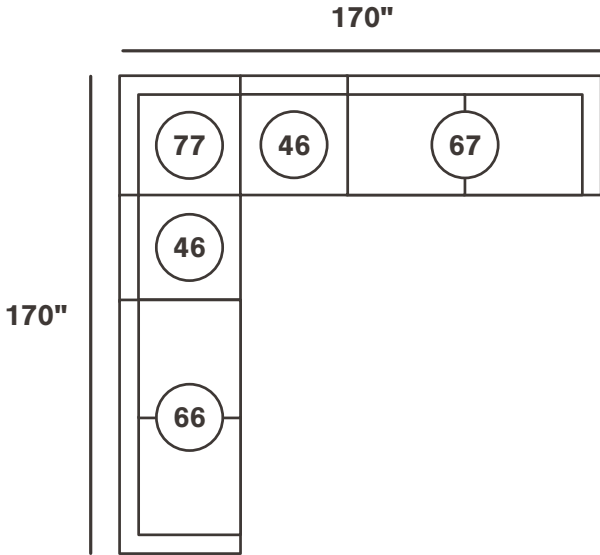
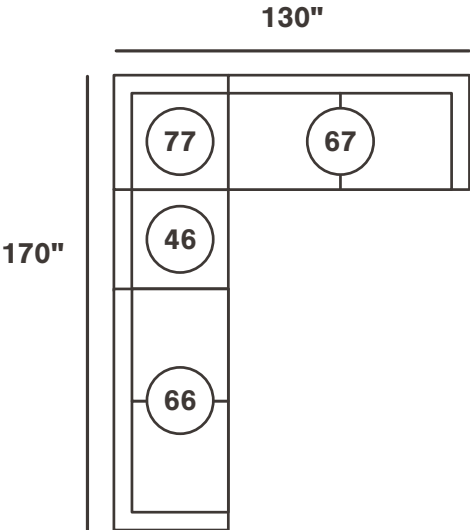
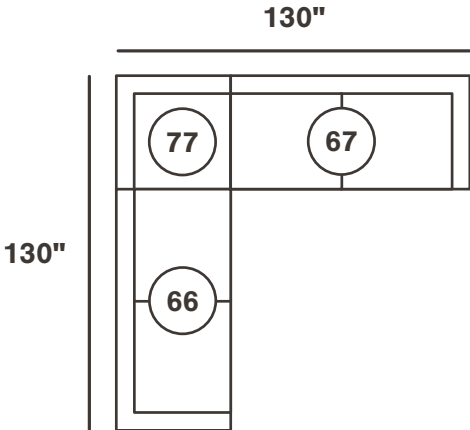
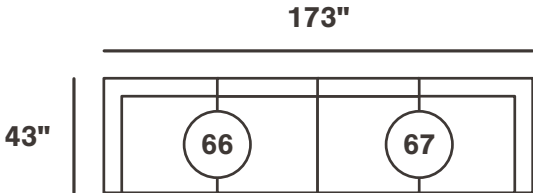

*All measurements are approximations.



INDIVIDUAL PIECES

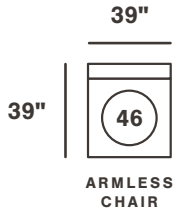
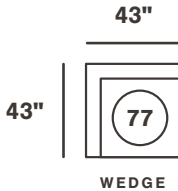
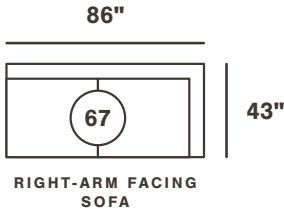
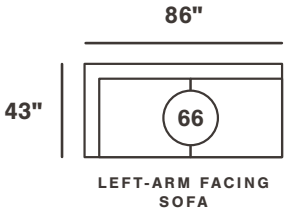

ADDITIONAL PIECES

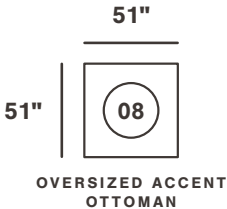

*All measurements are approximations.

regent park 144

OUR FAVORITE CONFIGURATIONS

Reverse configurations available.

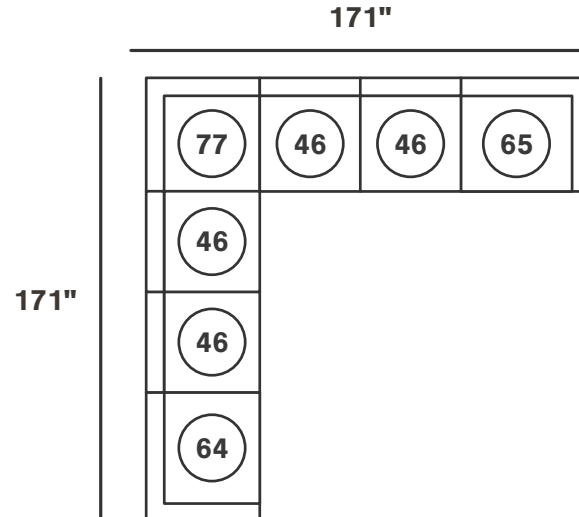
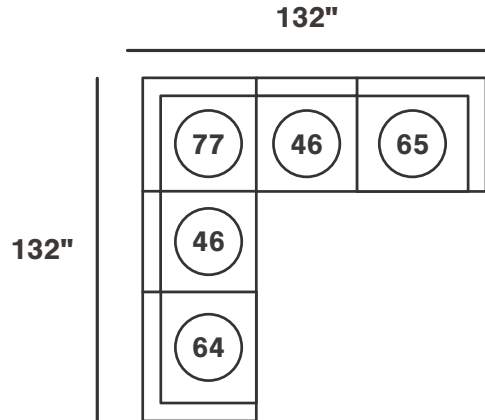
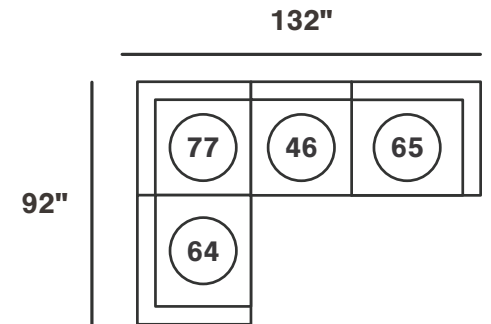
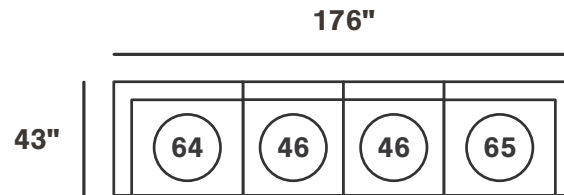
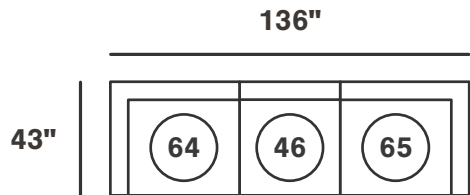

*All measurements are approximations.



regent park 144

INDIVIDUAL PIECES

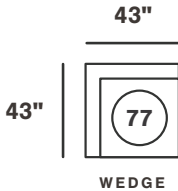
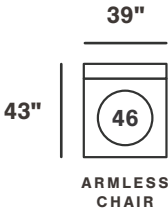
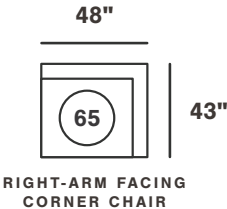
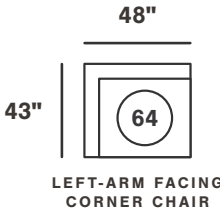

ADDITIONAL PIECES

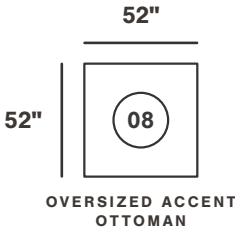

*All measurements are approximations.

sophie 157

OUR FAVORITE CONFIGURATIONS

Reverse configurations available.

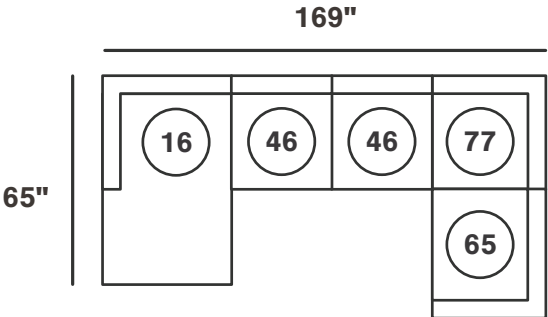
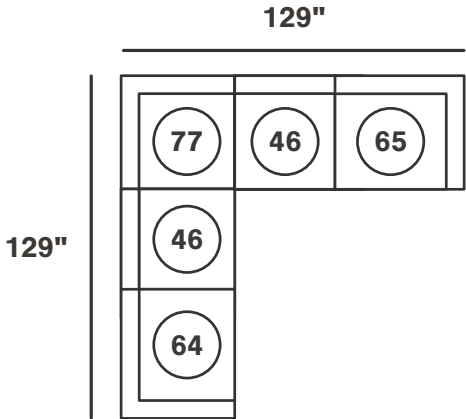
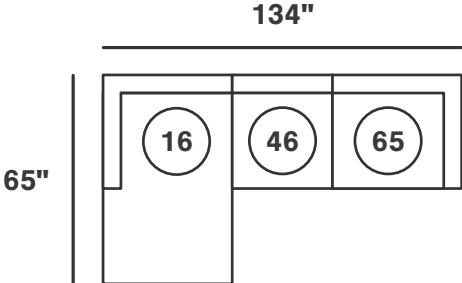
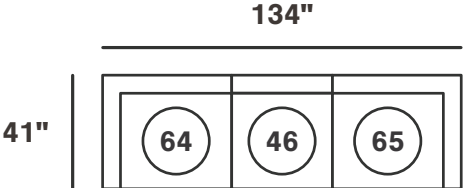
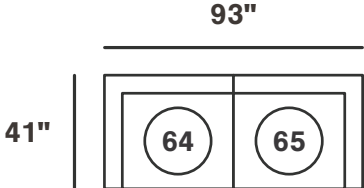

*All measurements are approximations.



INDIVIDUAL PIECES

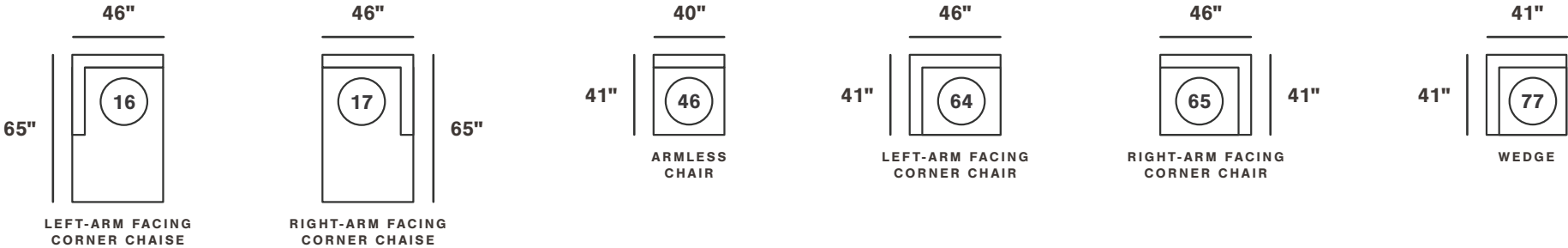

ADDITIONAL PIECES

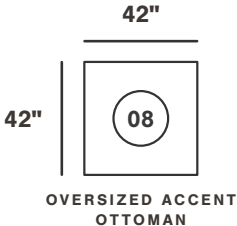

*All measurements are approximations.

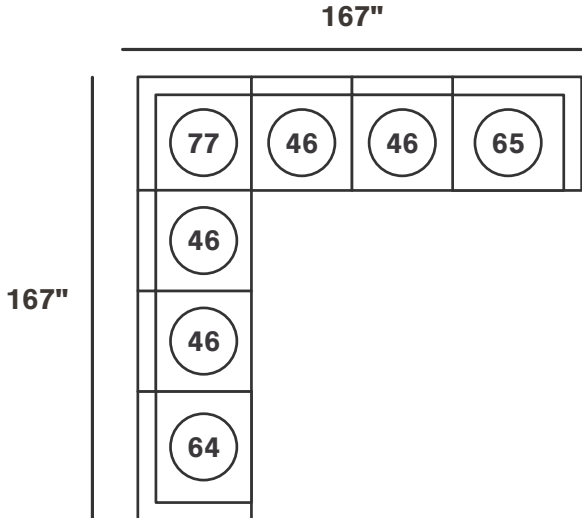
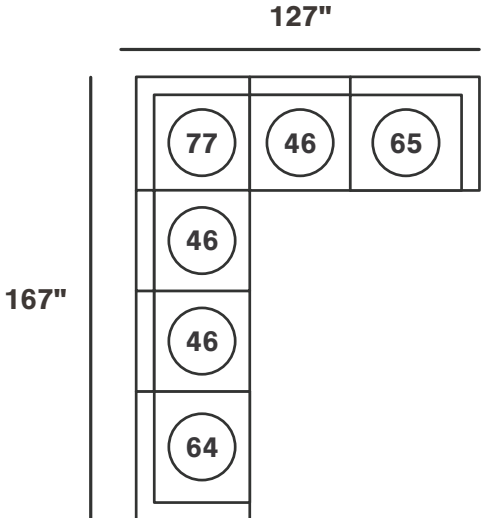
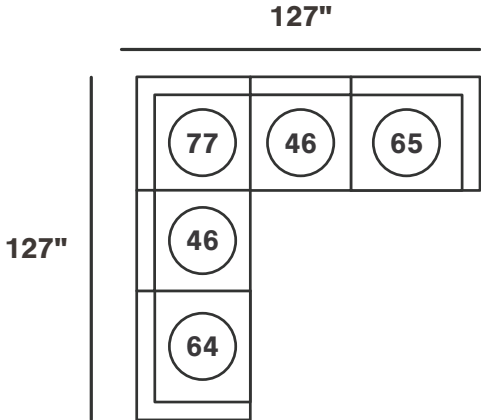
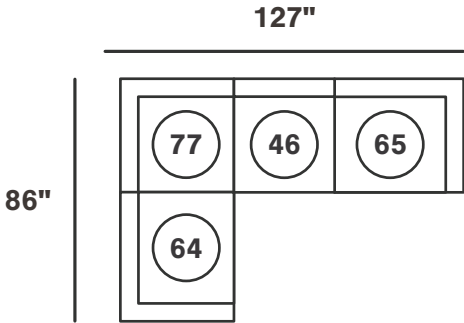
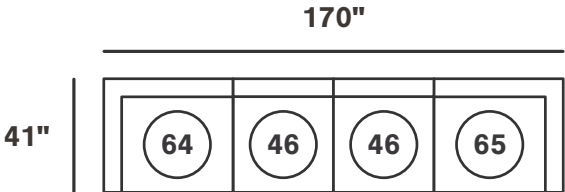
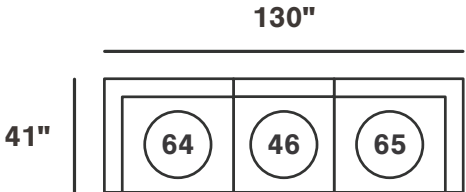

*All measurements are approximations.



INDIVIDUAL PIECES

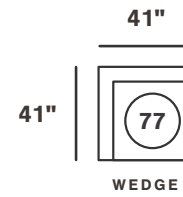
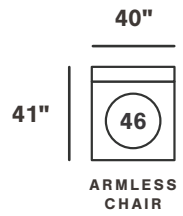
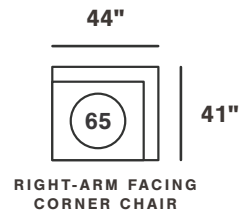
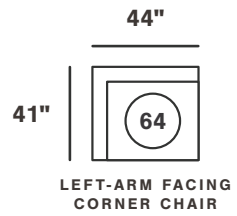

ADDITIONAL PIECES

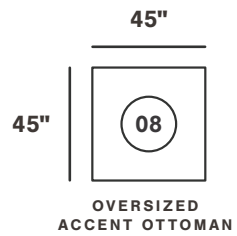

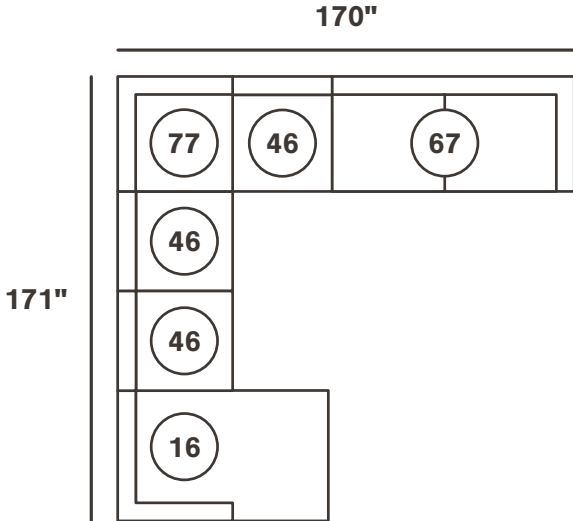
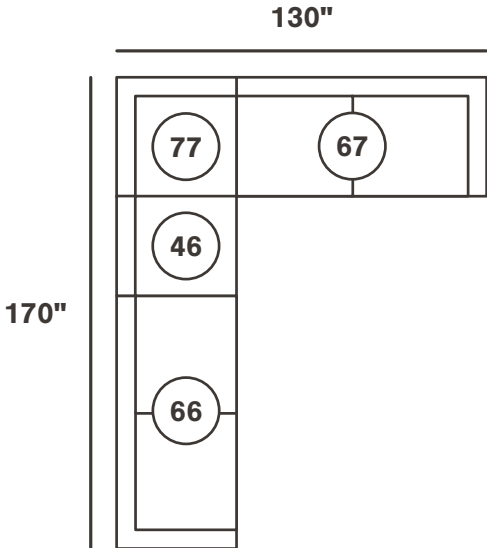
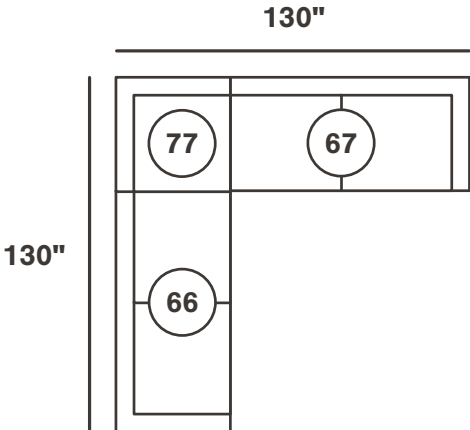
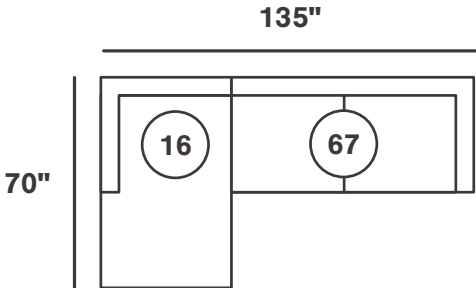

*All measurements are approximations.



zada 522

INDIVIDUAL PIECES

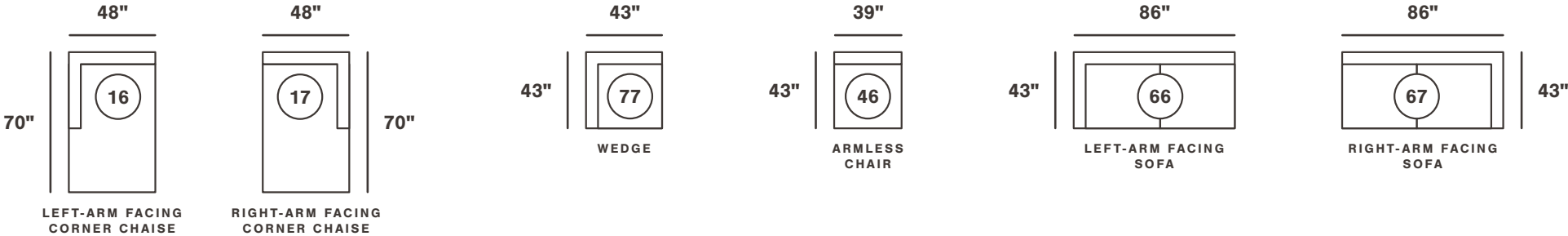

ADDITIONAL PIECES

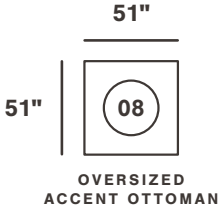

*All measurements are approximations.